



Guangdong Lesso Energy Storage Technology Co., Ltd
Daba Industrial Area, Longjiang Town, Foshan City, Guangdong Province, China
LESSO Group (2128) is listed in the Stock Exchange of Hong Kong.

www.lessosolar.com energy@lessosolar.com [f](#) [in](#) [v](#) [@](#) LESSO Solar

A LESSO Solar Publication, September 2024. Data contained in these specifications is subject to change without notice.

Energy Storage Product Manual

Solar Inverter | Battery | Portable Energy Storage | EV Charger |
Industrial and Commercial Energy Storage System

A Bright and Exciting Journey

LESSO Group is a Hong Kong-listed (2128.HK) manufacturer of building materials with an annual revenue of over USD 4.38 billion from its global operations.

Guangdong Lesso Energy Storage Technology Co., Ltd. is a comprehensive energy storage technology integrator that specializes in R&D, production, sales, and after-sales services.

Our comprehensive product line ranges from residential energy storage, portable energy storage, industrial and commercial energy storage, inverters and EV charging equipment to other energy storage products. We are committed to providing safe, efficient, and comprehensive energy storage solutions.



USD4.38 bil
Annual Sales Revenue



38 years
Production Experience



3.5GWh+
Production Capacity



Product Certification And Achievements Recognition



CQC



ISO



TUV



TUV Rheinland



PCCC



FCC



UKCA



RoHS



UN38.3



PSE



CB



CCC



CE



ETL



MSDS



UL



VDE



LESSO Solar Global Footprint

Drawing upon the extensive resources of LESSO, the global footprint of LESSO solar has covered Asia, North America, South America, Europe, South Africa, and the Middle East. Our commitment is to provide a wide range of new energy solutions and services to customers worldwide. With a focus on expanding our global production, logistics, sales, and service network, we aim to meet the diverse needs of customers all over the world.

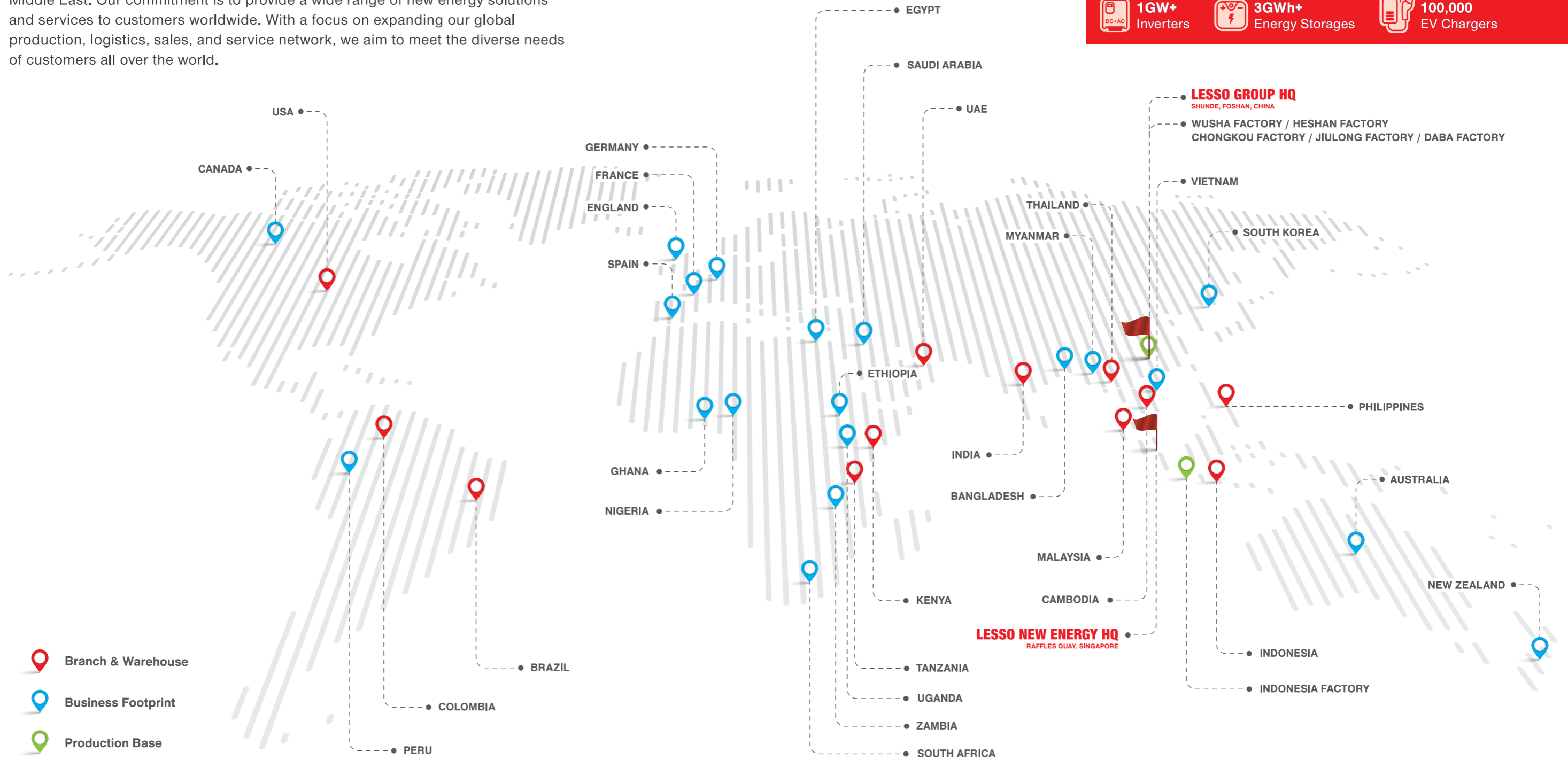

CHONGKOU FACTORY



1GW+ Inverters
 3GWh+ Energy Storages
 100,000 EV Chargers

Inverter series

Safe and Reliable, User-friendly and Economical

- Residential Inverters
- Commercial & Industrial Inverters
- Residential Storage Inverters





Micro PV Inverter

LSMT300TL-H1
LSMT350TL-H1
LSMT400TL-H1

Micro PV Inverter Highlights

1. Single unit connects up to 1 PV module.
2. Maximum 300W/350W/400W AC output power.
3. Single phase output, Flexible 3-phase PV system.
4. WIFI communication and cloud monitoring.
5. Customizable various input (DV PV) voltage range.
6. Integrated AC bus cable, ready-to-use.
7. Low cost, easy installation.

Single phase connection method of micro inverter

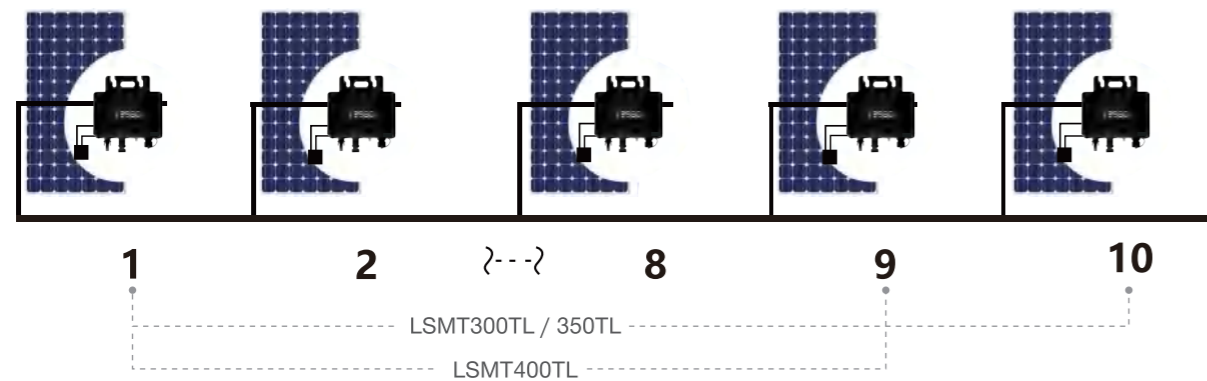

- LSMT300TL / 350TL Up to 10 units per branch (230V); LSMT400TL Up to 9 units per branch (230V).
- The VOC of PV modules should not be greater than the max DC input voltage of micro PV inverter

	Model	LSMT300TL-H1	LSMT350TL-H1	LSMT400TL-H1
DC Input	Number of input MC4 connector	1 set		
	MPPT voltage range	16V-48V		
	Operation voltage range	20-50V		
	Maximum Input voltage	50V		
	Startup voltage	18V		
	Maximum input power	300W	350W	400W
	Maximum input current	12A	14A	16A
AC Output	Single-phase grid type	L,N,PE 120V/230V		
	Rated output power	300W	350W	400W
	Maximum output power	300W	350W	400W
	Nominal output current	@120VAC:2.5A/@230VAC:1.3A		
	Nominal output voltage	120VAC /230VAC		
	Default output voltage range	@120VAC:80V-160V/@230VAC:180V-270V		
	Nominal output frequency	50Hz / 60Hz		
	Default output frequency range	@50Hz:48Hz-51Hz/@60Hz:58Hz-61Hz		
	Power Factor	>0.99%		
	Total harmonic distortion	THD <5%		
Efficiency	Maximum units per branch	@120VAC:5units /300W-350W @230VAC: 10units; 400W @230VAC: 9units		
	Nominal MPPT efficiency	99.5%		
	Peak efficiency	95%		
Mechanical Data	Night power consumption	<1W		
	Operating ambient temperature range	-40°C to +65°C		
	Storage temperature range	-40°C to +85°C		
	Dimensions (L × W ×H)	195mm x 185mm x 40mm		
	Weight	1.6kg		
	Max current of AC bus cable	20A		
	Waterproof rating	IP66		
Other Features	Cooling mode	Natural convection - no fans		
	Communication	WIFI(cloud monitoring)		
	Power transmission mode	Reverse transfer, load priority		
	Monitoring system	Mobile APP, PC browser		
	Transformer design	High frequency transformers,galvanically isolated		
	Integrated ground	Equipment ground is provided by the PE in the AC cable. No additional ground is required		
	Protection Functions	Isolated island protection,voltage protection, frequency protection, temperature protection, current protection, etc.		
	Design compliance	EN IEC61000-3-2:2019+A1:2021, EN 61000-3-3:2013+A1:2019+A2:2021, EN IEC55014-2:2021		
Certificate	CE			



Micro PV Inverter

LSMT600TL-H1
LSMT700TL-H1
LSMT800TL-H1

Micro PV Inverter Highlights

1. Single unit connects up to 2 PV module.
2. Maximum 600W/700W/800W AC output power.
3. Single phase output, Flexible 3-phase PV system.
4. WIFI communication and cloud monitoring.
5. Customizable various input (DV PV) voltage range.
6. Integrated AC bus cable, ready-to-use.
7. Low cost, easy installation.

Single phase connection method of micro inverter

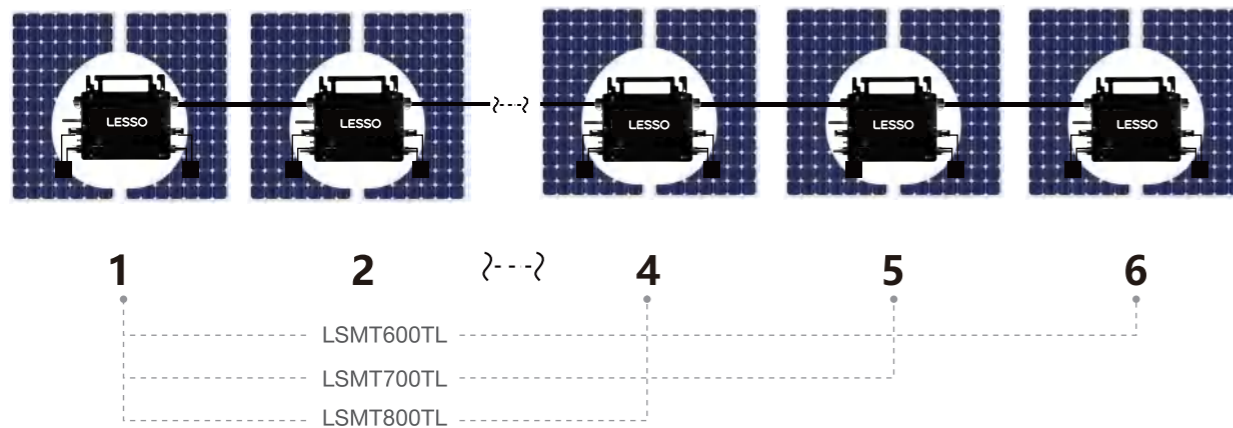

- LSMT600TL Up to 6 units per branch (230V); LSMT700TL Up to 5 units per branch (230V); LSMT800TL Up to 4 units per branch (230V).
- The VOC of PV modules should not be greater than the max DC input voltage of micro PV inverter.

Model	LSMT600TL-H1	LSMT700TL-H1	LSMT800TL-H1	
DC Input	Number of input MC4 connector	2 sets		
	MPPT voltage range	22V-48V		
	Operation voltage range	20-50V		
	Maximum Input voltage	52V		
	Startup voltage	18V		
	Maximum input power	600W	700W	800W
	Maximum input current	12A*2	14A*2	16A*2
	AC Output	Single-phase grid type	L,N,PE 120V/230V	
Rated output power		600W	700W	800W
Maximum output power		600W	700W	800W
Nominal output current		@120VAC:5A @230VAC:2.6A	@120VAC:5.8A @230VAC:3A	@120VAC:6A @230VAC:3.5A
Nominal output voltage		120VAC /230VAC		
Default output voltage range		@120VAC:80V-160V/@230VAC:180V-270V		
Nominal output frequency		50Hz / 60Hz		
Default output frequency range		@50Hz:48Hz-51Hz/@60Hz:58Hz-61Hz		
Power Factor		>0.99%		
Total harmonic distortion		THD <5%		
Maximum units per branch		LSMT600TL-H1: @120VAC:3units /@230VAC: 6units LSMT700TL-H1: @120VAC:3units /@230VAC: 5units LSMT800TL-H1: @120VAC:3units /@230VAC: 4units		
Efficiency		Nominal MPPT efficiency	99.5%	
	Peak efficiency	95%		
	Night power consumption	<1W		
Mechanical Data	Operating ambient temperature range	-40°C to +65°C		
	Storage temperature range	-40°C to +85°C		
	Dimensions (L × W ×H)	230mm x 185mm x 45mm		
	Weight	2kg		
	Max current of AC bus cable	20A		
	Waterproof rating	IP66		
	Cooling mode	Natural convection - no fans		
Other Features	Communication	WIFI(cloud monitoring)		
	Power transmission mode	Reverse transfer, load priority		
	Monitoring system	Mobile APP, PC browser		
	Transformer design	High frequency transformers,galvanically isolated		
	Integrated ground	Equipment ground is provided by the PE in the AC cable. No additional ground is required		
	Protection Functions	Isolated island protection,voltage protection, frequency protection, temperature protection, current protection, etc.		
	Design compliance	EN IEC61000-3-2:2019+A1:2021, EN 61000-3-3:2013+A1:2019+A2:2021, EN IEC55014-2:2021		
Certificate	CE			



Micro PV Inverter

- LSMT1200TL-H1
- LSMT1400TL-H1
- LSMT1600TL-H1
- LSMT2000TL-H1

Micro PV Inverter Highlights

1. Single unit connects up to 4 PV module.
2. Maximum 1200W/1400W/1600W/2000W AC output power.
3. Single phase output, Flexible 3-phase PV system.
4. WIFI communication and cloud monitoring.
5. Customizable various input (DV PV) voltage range.
6. Integrated AC bus cable, ready-to-use.
7. Low cost, easy installation.

Single phase connection method of micro inverter

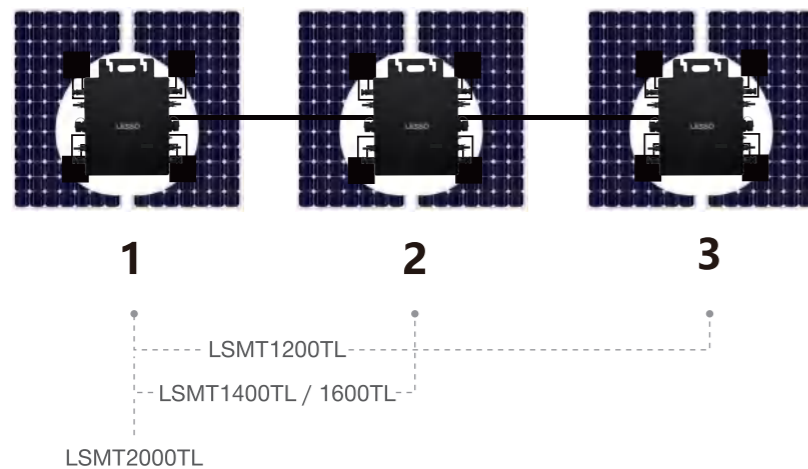

- LSMT1200TL Up to 3 units per branch (230V); LSMT1400TL Up to 2 units per branch (230V); LSMT1600TL Up to 2 units per branch (230V); LSMT2000TL Up to 1 units per branch (230V).
- The VOC of PV modules should not be greater than the max DC input voltage of micro PV inverter.

Model	LSMT1200TL-H1	LSMT1400TL-H1	LSMT1600TL-H1	LSMT2000TL-H1	
DC Input	Number of input MC4 connector				
	MPPT voltage range				
	Operation voltage range				
	Maximum Input voltage				
	Startup voltage				
	Maximum input power	1200W	1400W	1600W	2000W
	Maximum input current	12A*4	14A*4	15A*4	16A*4
AC Output	Single-phase grid type				
	Rated output power	1200W	1400W	1600W	2000W
	Maximum output power	1200W	1400W	1600W	2000W
	Nominal output current	@120VAC:10A @230VAC:5.2A	@120VAC:11.6A @230VAC:6A	@120VAC:13A @230VAC:6.9A	@120VAC:16.6A @230VAC:8.A
	Nominal output voltage	120VAC /230VAC			
	Default output voltage range	@120VAC:80V-160V/@230VAC:180V-270V			
	Nominal output frequency	50Hz / 60Hz			
	Default output frequency range	@50Hz:48Hz-51Hz/@60Hz:58Hz-61Hz			
	Power Factor	>0.99%			
	Total harmonic distortion	THD <5%			
	Maximum units per branch	LSMT1200TL-H1: @120VAC:2units /@230VAC: 4units LSMT1400TL / 1600TL-H1: @120VAC:2units /@230VAC: 4units (AC cable 3*2.5mm ²) LSMT2000TL-H1: @120VAC:2units /@230VAC: 1units (AC cable 3*2.5mm ²)			
Efficiency	Nominal MPPT efficiency				
	Peak efficiency				
	Night power consumption				
Mechanical Data	Operating ambient temperature range				
	Storage temperature range				
	Dimensions (L × W ×H)				
	Weight	3.7kg		3.5kg	
	Max current of AC bus cable	20A			
	Waterproof rating	IP66			
	Cooling mode	Natural convection - no fans			
Other Features	Communication				
	Power transmission mode				
	Monitoring system				
	Transformer design				
	Integrated ground	Equipment ground is provided by the PE in the AC cable. No additional ground is required			
	Protection Functions	Isolated island protection,voltage protection, frequency protection, temperature protection, current protection, etc.			
	Design compliance	EN IEC61000-3-2:2019+A1:2021, EN 61000-3-3:2013+A1:2019+A2:2021, EN IEC55014-2:2021			
	Certificate	CE			

LESSO

LSBH(2K5~6K)TL

Single Phase PV Inverter

>> Models:

- LSBH2K5TL LSBH4K6TL
- LSBH3KTL LSBH5KTL
- LSBH3K6TL LSBH6KTL
- LSBH4KTL



Features:

- Max. efficiency 97.7%
- String current up to 14A
- Super high frequency switching technology
- Wide voltage range and low startup voltage
- 2 MPPT design with precise MPPT algorithm
- Intergrated Export Power Manager (EPM)
- AFCI protection, proactively reduces fire risk
- Compact and lightweight
- Friendly and adaptable connection to the grid

LESSO

Single Phase PV Inverter

DATASHEET

LSBH(2K5~6K)TL

Models	2.5K	3K	3.6K	4K	4.6K	5K	6K
Input DC							
Recommended max.PV power	3.75 kW	4.5 kW	5.4 kW	6 kW	6.9 kW	7.5 kW	9 kW
Max. input voltage	550 V	600 V					
Rated voltage	250 V	330 V					
Start-up voltage	60 V	120 V					
MPPT voltage range	50-450 V	90-520 V					
Max. input current				14 A / 14 A			
Max. short circuit current				22 A / 22 A			
MPPT number/Max. input strings number				2/2			
Output AC							
Rated output power	2.5 kW	3 kW	3.6 kW	4 kW	4.6 kW	5 kW	6 kW
Max. apparent output power	2.8 kVA	3.3 kVA	4 kVA	4.4 kVA	5 kVA	5 kVA	6 kVA
Max. output power	2.8 kW	3.3 kW	4 kW	4.4 kW	5 kW	5 kW	6 kW
Rated grid voltage	L,N,PE, 220 V / 230 V						
Rated grid frequency	50 Hz / 60 Hz						
Rated grid output current	11.4 A / 10.9 A	13.6 A / 13.0 A	16.0 A / 15.7 A	18.2 A / 17.4 A	20.9 A / 20.0 A	22.7 A / 21.7 A	27.3 A
Max. output current	13.3 A	15.7 A	16.0 A	21.0 A	23.8 A	25.0 A	27.3 A
Power factor	>0.99 (0.8 leading - 0.8 lagging)						
THDi	<3%						
Efficiency							
Max. efficiency	97.3%	97.3%	97.6%		97.7%		
EU efficiency	96.5%	96.6%	97.1%		97.1%		
Protection							
DC reverse-polarity protection	Yes						
Short circuit protection	Yes						
Output over current protection	Yes						
Surge protection	Yes						
Grid monitoring	Yes						
Anti-islanding protection	Yes						
Temperature protection	Yes						
Integrated AFCI (DC arc-fault circuit protection)	Yes ⁽¹⁾						
Integrated DC switch	Optional						
General Data							
Dimensions (W*H*D)	310*543*160 mm						
Weight	11 kg	11.2 kg	12 kg				
Topology	Transformerless						
Self-consumption (night)	<1 W						
Operating ambient temperature range	-25 ~ +60°C						
Relative humidity	0-100%						
Ingress protection	IP66						
Cooling concept	Natural convection						
Max. operation altitude	4000 m						
Grid connection standard	G98 or G99, VDE-AR-N 4105 / VDE V 0124, EN 50549-1, VDE 0126 / UTE C 15 / VFR:2019, RD 1699 / RD 244 / UNE 206006 / UNE 206007-1, CEI 0-21, C10/11, NRS 097-2-1, EFS 2018.2, IEC 62116, IEC 61727, IEC 60068, IEC 61683, EN 50530, MEA, PEA						
Safety/EMC standard	IEC/EN 62109-1/-2, IEC/EN 61000-6-2/-3						
Features							
DC connection	MC4 connector						
AC connection	Quick connection plug						
Display	LCD, 2x20 Z.						
Communication	RS485, Optional: Wi-Fi, GPRS						

(1) Activation required.

Guangdong Lesso Energy Storage Technology Co., Ltd

Daba Industrial Area, Longjiang Town, Foshan City, Guangdong Province, China

LESSO Solar

energy@lessosolar.com www.lessosolar.com

LESSO

LSBH(3~20)KTL3

Three Phase PV Inverter

>> Models:

- | | |
|-----------|------------|
| LSBH3KTL3 | LSBH10KTL3 |
| LSBH4KTL3 | LSBH12KTL3 |
| LSBH5KTL3 | LSBH13KTL3 |
| LSBH6KTL3 | LSBH15KTL3 |
| LSBH8KTL3 | LSBH17KTL3 |
| LSBH9KTL3 | LSBH20KTL3 |



Efficient

- Max. efficiency 98.7%
- String current up to 16A
- Wide voltage range and low startup voltage

Smart

- Supports export power control
- Supports RS485, WiFi, GPRS
- Scan to register on Lesso PV cloud, supports remote upgrade and control

Safe

- IP66
- AFCI protection, proactively reduces fire risk
- Automatic voltage stabilization technology in weak grid conditions

Economic

- Compact design, simple installation and maintenance
- > 150% DC/AC ratio
- Supports high power modules for lower installation costs

LESSO

Three Phase PV Inverter

DATASHEET

LSBH(3~20)KTL3

Models	3K	4K	5K	6K	8K	9K	10K	12K	13K	15K	17K	20K	
Input DC													
Recommended max.PV power	4.5 kW	6 kW	7.5 kW	9 kW	12 kW	13.5 kW	15 kW	18 kW	19.5 kW	22.5 kW	25.5 kW	30 kW	
Max. input voltage	1100 V												
Rated voltage	600 V												
Start-up voltage	180 V												
MPPT voltage range	160-1000 V												
Max. input current	16 A / 16 A						32 A / 32 A						
Max. short circuit current	20 A / 20 A						40 A / 40 A						
MPPT number/Max. input strings number	2/2						2/4						
Output AC													
Rated output power	3 kW	4 kW	5 kW	6 kW	8 kW	9 kW	10 kW	12 kW	13 kW	15 kW	17 kW	20 kW	
Max. apparent output power	3.3 kVA	4.4 kVA	5.5 kVA	6.6 kVA	8.8 kVA	9.9 kVA	11 kVA	13.2 kVA	14.3 kVA	16.5 kVA	18.7 kVA	22 kVA	
Max. output power	3.3 kW	4.4 kW	5.5 kW	6.6 kW	8.8 kW	9.9 kW	11 kW	13.2 kW	14.3 kW	16.5 kW	18.7 kW	22 kW	
Rated grid voltage	3L,N,PE, 220 V / 380 V, 230 V / 400 V												
Rated grid frequency	50 Hz / 60 Hz												
Rated grid output current	4.6 A / 4.3 A	6.1 A / 5.8 A	7.6 A / 7.2 A	9.1 A / 8.7 A	12.2 A / 11.5 A	13.7 A / 13.0 A	15.2 A / 14.4 A	18.2 A / 17.3 A	19.8 A / 18.8 A	22.8 A / 21.7 A	25.8 A / 24.6 A	30.4 A / 28.9 A	
Max. output current	4.7 A	6.4 A	7.9 A	9.5 A	12.7 A	14.3 A	15.9 A	19.1 A	20.7 A	23.8 A	27 A	31.8 A	
Power factor	>0.99 (0.8 leading - 0.8 lagging)												
THDi	<2%												
Efficiency													
Max. efficiency	98.3%				98.5%				98.6%				98.7%
EU efficiency	97.7%				97.9%				98.0%				98.1%
Protection													
DC reverse-polarity protection	Yes												
Short circuit protection	Yes												
Output over current protection	Yes												
Surge protection	Yes												
Grid monitoring	Yes												
Anti-islanding protection	Yes												
Temperature protection	Yes												
Integrated AFCI (DC arc-fault circuit protection)	Yes ⁽¹⁾												
Integrated DC switch	Optional												
General Data													
Dimensions (W*H*D)	310*563*219 mm												
Weight	17.8 kg				18.8 kg				20 kg				
Topology	Transformerless												
Self-consumption (night)	<1 W												
Operating ambient temperature range	-25 ~ +60°C												
Relative humidity	0-100%												
Ingress protection	IP66												
Cooling concept	Natural convection						Intelligent redundant fan-cooling						
Max. operation altitude	4000 m												
Grid connection standard	G98 or G99, VDE-AR-N 4105 / VDE V 0124, EN 50549-1, VDE 0126 / UTE C 15 / VFR:2019, RD 1699 / RD 244 / UNE 206006 / UNE 206007-1, CEI 0-21, C10/11, NRS 097-2-1, EIFS 2018.2, IEC 62116, IEC 61727, IEC 60068, IEC 61683, EN 50530												
Safety/EMC standard	IEC/EN 62109-1/-2, IEC/EN 61000-6-1/-2/-3/-4												
Features													
DC connection	MC4 connector												
AC connection	Quick connection plug												
Display	LCD, 2x20 Z.												
Communication	RS485, Optional: Wi-Fi, GPRS												

(1) Activation required.



PV Inverter

LSBH (6~30) KTL3-OC1

Product Model	LSBH6KTL3-OC1	LSBH8KTL3-OC1	LSBH10KTL3-OC1	LSBH12KTL3-OC1	LSBH15KTL3-OC1	LSBH17KTL3-OC1	
Input	Max. DC Input Power	7800W	10400W	13000W	15600W	19500W	22600W
	Max. DC Input Voltage	1100V					
	Max. DC Input Current	18/18A			18/30A		
	MPPT Voltage Range	180~1000V					
	Recommended Working Voltage	650V					
	MPPT Number	2					
	Max. Input Strings per MPPT	1/1			1/2		
Output	Rated Output Power	6000W	8000W	10000W	12000W	15000W	17000W
	Max. AC Power	6.6kVA	8.8kVA	11kVA	13.2kVA	16.5kVA	18.7kVA
	Max. Output Current	10A	13.3A	16.7A	20A	25A	28.3A
	Rated Power Grid Voltage	400V					
	Power Grid Voltage Range	310~480Vac					
	Rated Power Grid Frequency	50Hz/60Hz					
	Grid Frequency Range	45~55Hz/55~65Hz					
	THD	<2% (under rated power)					
	Power Factor	>0.99 (under rated power) / Adjustable range0.8(leading)~0.8(lagging)					
	DC Component	<0.5% (under rated power)					
System Data	Max. Efficiency	98.5%	98.5%	98.6%	98.7%	98.7%	98.7%
	Euro. efficiency	98%	98%	98.2%	98.1%	98.2%	98.2%
	Humidity	0~100%, no condensation					
	Cooling	Fan					
	Ambient Temperature Range	-25~+60°C					
	Consumption During Night	<1W					
	Altitude	4000m					
	Display	LED/LCD (optional)					
	Communication Interface	RS485/GPRS/Wifi (optional)					
	Mechanical Data	Size	427x510x190mm			427x439x212mm	
Weight		15kg			18kg		
Protection Level		IP66					
Conforming Standards	Standards for Grid Connection	NB/T 32004-2018; IEC61727					
	Safety Standard	NB/T 32004-2018; EC 62109-1/2					
	EMC	IEC61000-6-2/4					

Product Model	LSBH20KTL3-OC1	LSBH23KTL3-OC1	LSBH25KTL3-OC1	LSBH28KTL3-OC1	LSBH30KTL3-OC1	
Input	Max. DC Input Power	26000W	29900W	32500W	36400W	36000W
	Max. DC Input Voltage	1100V				
	Max. DC Input Current	30/30A		36/30A	36/36A	36/36A
	MPPT Voltage Range	180~1000V				
	Recommended Working Voltage	650V				
	MPPT Number	2				
	Max. Input Strings per MPPT	2/2				2/2
Output	Rated Output Power	20000W	23000W	25000W	28000W	30000W
	Max. AC Power	22kVA	25.3kVA	27.5kVA	30.8kVA	33kVA
	Max. Output Current	32A	36.5A	42A	45A	48A
	Rated Power Grid Voltage	400V				
	Power Grid Voltage Range	310~480Vac				
	Rated Power Grid Frequency	50Hz/60Hz				
	Grid Frequency Range	45~55Hz/55~65Hz				
	THD	<2% (under rated power)				
	Power Factor	>0.99 (under rated power) / Adjustable range0.8(leading)~0.8(lagging)				
	DC Component	<0.5% (under rated power)				
System Data	Max. Efficiency	98.7%	98.8%	98.8%	98.8%	98.8%
	Euro. efficiency	98.2%	98.2%	98.2%	98.2%	98.2%
	Humidity	0~100%, no condensation				
	Cooling	Fan				
	Ambient Temperature Range	-25~+60°C				
	Consumption During Night	<1W				
	Altitude	4000m				
	Display	LED/LCD (optional)				
	Communication Interface	RS485/GPRS/Wifi (optional)				
	Mechanical Data	Size	427*439*212mm			
Weight		18kg				
Protection Level		IP66				
Conforming Standards	Standards for Grid Connection	NB/T 32004-2018; IEC61727				
	Safety Standard	NB/T 32004-2018; EC 62109-1/2				
	EMC	IEC61000-6-2/4				

Remarks: Specifications are subject to change without notice; Special voltage and power requirements can be customized designed

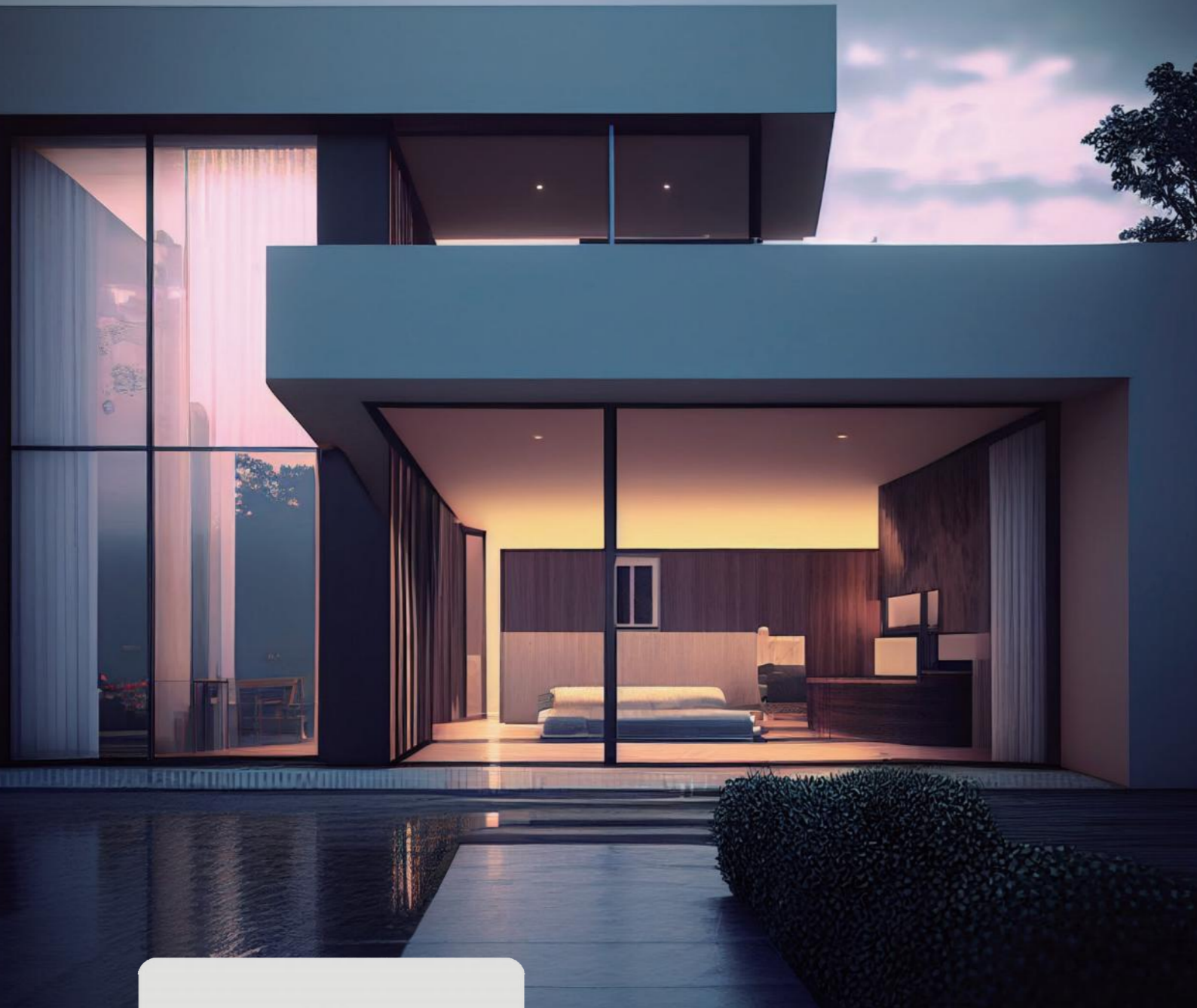

Product Model	LSBH33KTL3-OC1	LSBH36KTL3-OC1	LSBH40KTL3-OC1	LSBH50KTL3-OC1	
Input	Max. DC Input Power	39600W	43200W	48000W	60000W
	Max. DC Input Voltage	1100V			
	Max. DC Input Current	36A/36A/20A		36A/36A/20A/20A	
	MPPT Voltage Range	200~1000Vdc			
	Recommended Working Voltage	650V			
	MPPT Number	3	4		
	Max. Input Strings per MPPT	2/2/2		2/2/2/2	
Output	Rated Output Power	33000W	36000W	40000W	50000W
	Max. AC Power	36.3kVA	39.6kVA	44kVA	55kVA
	Max. Output Current	53A	56A	65A	80A
	Rated Power Grid Voltage	400V			
	Power Grid Voltage Range	310~480Vac			
	Rated Power Grid Frequency	50Hz/60Hz			
	Grid Frequency Range	45~55Hz/55~65Hz			
	THD	<2% (under rated power)			
	Power Factor	>0.99 (under rated power) / Adjustable range 0.8(leading)~0.8(lagging)			
	DC Component	<0.5% (under rated power)			
System Data	Max. Efficiency	98.6%	98.6%	98.6%	98.7%
	Euro. efficiency	98.1%	98.1%	98.2%	98.2%
	Humidity	0~100%, no condensation			
	Cooling	Fan			
	Ambient Temperature Range	-25~+60°C			
	Consumption During Night	<1W			
	Altitude	4000m			
	Display	LED /LCD (optional)			
	Communication Interface	RS485/GPRS/Wifi (optional)			
Mechanical Data	Size	610 x 564 x 218mm			
	Weight	37kg			39kg
	Protection Level	IP66			
Conforming Standards	Standards for Grid Connection	NB/T 32004-2018; IEC61727			
	Safety Standard	NB/T 32004-2018; EC 62109-1/2			
	EMC	IEC61000-6-2/4			

Remarks: Specifications are subject to change without notice; Special voltage and power requirements can be customized designed



PV Inverter

LSBH (33~50) KTL3-OC

LSBH(25~50)KTL3(-E1)

Three Phase PV Inverter

>> Models:

- LSBH25KTL3
- LSBH30KTL3
- LSBH33KTL3
- LSBH36KTL3
- LSBH40KTL3
- LSBH40KTL3-E1
- LSBH50KTL3-E1



DATASHEET

LSBH(25~40)KTL3

LSBH(40~50)KTL3-E1

Models	25K	30K	33K	36K	40K	40K-HV	50K-HV
Input DC							
Recommended max.PV power	37.5 kW	45 kW	49.5 kW	54 kW	60 kW	60 kW	75 kW
Max. input voltage	1100 V						
Rated voltage	600 V						
Start-up voltage	180 V						
MPPT voltage range	200-1000 V						
Max. input current	32 A / 32 A / 32 A				4*32 A		
Max. short circuit current	40 A / 40 A / 40 A				4*40 A		
MPPT number/Max. input strings number	3/6				4/8		
Output AC							
Rated output power	25 kW	30 kW	33 kW	36 kW	40 kW	40 kW	50 kW
Max. apparent output power	27.5 kVA	33 kVA	36.3 kVA	39.6 kVA	44 kVA	44 kVA	55 kVA
Max. output power	27.5 kW	33 kW	36.3 kW	39.6 kW	44 kW	44 kW	55 kW
Rated grid voltage	3L,N,PE, 220 V / 380 V, 230 V / 400 V					3L,PE, 480 V	
Rated grid frequency	50 Hz / 60 Hz						
Rated grid output current	38.0 A / 36.1 A	45.6 A / 43.3 A	50.1 A / 47.6 A	54.7 A / 52.0 A	60.8 A / 57.7 A	48.1 A	60.1 A
Max. output current	41.8 A	50.2 A	55.1 A	60.2 A	66.9 A	53.0 A	66.2 A
Power factor	>0.99 (0.8 leading - 0.8 lagging)						
THDi	<3%						
Efficiency							
Max. efficiency	98.5%	98.6%	98.7%	98.7%	98.7%	98.8%	98.8%
EU efficiency	98.1%	98.2%	98.3%	98.3%	98.3%	98.4%	98.4%
Protection							
DC reverse-polarity protection	Yes						
Short circuit protection	Yes						
Output over current protection	Yes						
Surge protection	DC Type II / AC Type II						
Grid monitoring	Yes						
Anti-islanding protection	Yes						
Temperature protection	Yes						
Strings monitoring	Yes						
I/V Curve scanning	Yes						
Integrated PID recovery	Optional						
Integrated AFCI (DC arc-fault circuit protection)	Yes ⁽¹⁾						
Integrated DC switch	Optional						
General Data							
Dimensions (W*H*D)	647*629*252 mm						
Weight	37 kg						
Topology	Transformerless						
Self-consumption (night)	<1 W						
Operating ambient temperature range	-25 ~ +60°C						
Relative humidity	0-100%						
Ingress protection	IP66						
Cooling concept	Intelligent redundant fan-cooling						
Max. operation altitude	4000 m						
Grid connection standard	G98 or G99, VDE-AR-N 4105 / VDE V 0124, EN 50549-1, VDE 0126 / UTE C 15 / VFR:2019, RD 1699 / RD 244 / UNE 206006 / UNE 206007-1, CEI 0-21, C10/11, NRS 097-2-1, EIFS 2018.2, IEC 62116, IEC 61727, IEC60068, IEC 61683, EN 50530						
Safety/EMC standard	IEC/EN 62109-1/-2, IEC/EN 61000-6-1/-2/-3/-4						
Features							
DC connection	MC4 connector						
AC connection	OT terminal						
Display	LCD, 2x20 Z.						
Communication	RS485, Optional: Wi-Fi, GPRS						

(1) Activation required.

Efficient

- Max. efficiency 98.8%
- String current up to 16A
- 3/4 MPPT design, supports multiple orientation system design
- Night time PID recovery function, increases overall system yield (optional)
- Wide voltage range and low startup voltage

Smart

- Supports export power control
- Intelligent string monitoring, smart I-V curve scan
- Supports RS485, WiFi, GPRS
- Scan to register on Lesso PV cloud, supports remote upgrade and control

Safe

- IP66
- AFCI protection, proactively reduces fire risk
- Globally recognised branded componentry for longer life
- Intelligent redundant fan-cooling

Economic

- Supports GPRS/WiFi communication with less wiring and reduced installation costs
- > 150% DC/AC ratio
- Supports high power modules for lower installation costs
- Supports aluminium wire access to reduce cost

LESSO

LSBH(50~70)KTL3(-E1)

Three Phase PV Inverter

>> Models:

LSBH50KTL3

LSBH60KTL3

LSBH60KTL3-E1

LSBH70KTL3-E1



LESSO

Three Phase PV Inverter

DATASHEET

LSBH(50~60)KTL3

LSBH(60~70)KTL3-E1

Models	50K	60K	60K-HV	70K-HV
Input DC				
Max. input voltage	1100 V			
Rated voltage	600 V		720 V	
Start-up voltage	195 V			
MPPT voltage range	180-1000 V			
Max. input current	5*32 A		6*32 A	
Max. short circuit current	5*40 A		6*40 A	
MPPT number/Max. input strings number	5/10		6/12	
Output AC				
Rated output power	50 kW	60 kW	60 kW	70 kW
Max. apparent output power	55 kVA	66 kVA	66 kVA	77 kVA
Max. output power	55 kW	66 kW	66 kW	77 kW
Rated grid voltage	3L,N,PE, 220 V / 380 V, 230 V / 400 V		3L,PE, 480 V	
Rated grid frequency	50 Hz / 60 Hz			
Rated grid output current	76.0 A / 72.2 A	91.2 A / 86.6 A	72.2 A	84.2 A
Max. output current	83.6 A	100.3 A	79.4 A	92.6 A
Power factor	>0.99 (0.8 leading - 0.8 lagging)			
THDi	<3%			
Efficiency				
Max. efficiency	98.7%			
EU efficiency	98.3%		98.4%	
Protection				
DC reverse-polarity protection	Yes			
Short circuit protection	Yes			
Output over current protection	Yes			
Surge protection	DC Type II / AC Type II			
Grid monitoring	Yes			
Anti-islanding protection	Yes			
Temperature protection	Yes			
Strings monitoring	Yes			
I/V Curve scanning	Yes			
Integrated AFCI (DC arc-fault circuit protection)	Yes ⁽¹⁾			
Integrated PID recovery	Optional ⁽²⁾			
Integrated DC switch	Optional			
General Data				
Dimensions (W*H*D)	691*578*338 mm			
Weight	54.5 kg			
Topology	Transformerless			
Self-consumption (night)	<1 W			
Operating ambient temperature range	-25 ~ +60°C			
Relative humidity	0-100%			
Ingress protection	IP66			
Cooling concept	Intelligent redundant fan-cooling			
Max. operation altitude	4000 m			
Grid connection standard	G99, VDE-AR-N 4105 / VDE V 0124, EN 50549-1, VDE 0126 / UTE C 15 / VFR:2019, RD 1699 / RD 244 / UNE 206006 / UNE 206007-1, CEI 0-21, C10/11, NRS 097-2-1, EIFS 2018.2, IEC 62116, IEC 61727, IEC60068, IEC 61683, EN 50530			
Safety/EMC standard	IEC 62109-1/-2, IEC62116 & IEC 61000-6-1/-2/-3/-4			
Features				
DC connection	MC4 connector			
AC connection	OT terminal (max.70 mm ²)			
Display	LCD, Capacitive touch buttons			
Communication	RS485, USB, Optional: Wi-Fi, GPRS			

(1) Activation required. (2) Due to the similar functional logic, when the night time PID-Recovery function is integrated, the night time var compensation function can not be used. Also, the negative grounding option is not available for inverters with night time PID-Recovery function.

Efficient

- Max. efficiency 98.7%
- String current up to 16A
- 5/6 MPPT design, supports multiple orientation system design
- Night time PID recovery function, increases overall system yield (optional)

Smart

- Night SVG function
- Supports export power control
- Intelligent string monitoring, smart I-V curve scan
- Scan to register on Lesso PV cloud, supports remote upgrade and control

Safe

- IP66, C5 Anti-Corrosion Level
- Intelligent redundant fan-cooling
- Globally recognised branded componentry for longer life
- AFCI protection, proactively reduces fire risk

Economic

- Supports GPRS/WiFi communication with less wiring and reduced installation costs
- DC side supports "Y" connector
- Supports aluminium wire access to reduce cost
- 10/12 string inputs allow for 150%+ DC oversizing

Guangdong Lesso Energy Storage Technology Co., Ltd

Daba Industrial Area, Longjiang Town, Foshan City, Guangdong Province, China

LESSO Solar

energy@lessosolar.com www.lessosolar.com

LESSO

LSBH(80~110)KTL3

Three Phase PV Inverter



>> Models:

LSBH80KTL3
LSBH100KTL3
LSBH110KTL3



Efficient

- 6/8 MPPTs, max. efficiency 98.7%
- > 150% DC/AC ratio
- Compatible with bifacial modules

Smart

- Night SVG function
- Intelligent string monitoring, smart I-V curve scan
- Remote firmware upgrade with simple operation

Safe

- IP66
- AFCI protection, proactively reduces fire risk
- Globally recognised branded componentry for longer life

Economic

- Power line communication (PLC) (optional)
- DC side supports "Y" connector
- Supports aluminium wire access to reduce cost

LESSO

Three Phase PV Inverter

DATASHEET

LSBH(80~110)KTL3

Models	80K	100K	110K
Input DC			
Max. input voltage	1100 V		
Rated voltage	600 V		
Start-up voltage	180 V		
MPPT voltage range	160-1000 V		
Max. input current	36 A / 32 A / 36 A / 32 A / 36 A / 32 A	36 A / 32 A / 36 A / 32 A / 36 A / 32 A / 36 A / 32 A	
Max. short circuit current	6*50 A	8*50 A	
MPPT number/Max. input strings number	6/12	8/16	
Output AC			
Rated output power	80 kW	100 kW	110 kW
Max. apparent output power	88 kVA	110 kVA	121 kVA
Max. output power	88 kW	110 kW	121 kW
Rated grid voltage	3L,N,PE, 220 V / 380 V, 230 V / 400 V		
Rated grid frequency	50 Hz / 60 Hz		
Rated grid output current	121.6 A / 115.5 A	152.0 A / 144.3 A	167.1 A / 158.8 A
Max. output current	133.7 A	167.1 A	183.8 A
Power factor	>0.99 (0.8 leading - 0.8 lagging)		
THDi	<3%		
Efficiency			
Max. efficiency	98.5%		
EU efficiency	98%		
Protection			
DC reverse-polarity protection	Yes		
Short circuit protection	Yes		
Output over current protection	Yes		
Surge protection	DC Type II / AC Type II		
Grid monitoring	Yes		
Anti-islanding protection	Yes		
Temperature protection	Yes		
Strings monitoring	Yes		
I/V Curve scanning	Yes		
Integrated AFCI (DC arc-fault circuit protection)	Yes ⁽¹⁾		
Integrated DC switch	Yes		
General Data			
Dimensions (W*H*D)	1065*585*363 mm (with AC switch)	1183*585*363 mm	
Weight	79.5 kg	93 kg	
Topology	Transformerless		
Self-consumption (night)	<2 W		
Operating ambient temperature range	-30 ~ +60°C		
Relative humidity	0-100%		
Ingress protection	IP66		
Cooling concept	Intelligent redundant fan-cooling		
Max. operation altitude	4000 m		
Grid connection standard	G99, IEC61727, EN50549-1/2, VDE4110		
Safety/EMC standard	IEC/EN 62109-1/-2, IEC/EN 61000-6-2/-4		
Features			
DC connection	MC4 connector		
AC connection	OT terminal (max.185 mm ²)		
Display	LCD, 2x20 Z		
Communication	RS485, Optional: Wi-Fi, GPRS, PLC		

(1) Activation required.

Guangdong Lesso Energy Storage Technology Co., Ltd

Daba Industrial Area, Longjiang Town, Foshan City, Guangdong Province, China

LESSO Solar

energy@lessosolar.com www.lessosolar.com



Residential Off-grid Inverter

- Dual MCU design, excellent performance;
- Power frequency, adapt to various types of loads;
- Comprehensive digital LCD display, easy to understand the working status of the machine
- Wide input voltage range, high-precision output, fully automatic voltage stabilization function
- LVD , HVD , charging voltage and turn off voltage, battery type/charging current settable
- Toroidal transformer, low no-load loss

Product Model	LSOT1K-C1	LSOT1K-C2	LSOT2K-C2	LSOT2K-C4	LSOT3K-C2	LSOT3K-C4	LSOT4K-C4	LSOT5K-C4	LSOT6K-C4
Rated Power	1000W		2000W		3000W		4000W	5000W	
Battery Voltage	12V	24V	24V	48V	24V	48V		48V	
Size (W*D*H mm)	540x265x180						580x340x210		
Package Size (W*D*H mm)	580x310x220						620x390x270		
Net Weight (kg)	10.5		15		17.5		20	24	
Gross Weight (kg)	13		17.5		20		23	27	
Input									
Phase	L+N+G								
AC Input Range	220V: 170-275VAC								
Frequency	45Hz~55Hz								
Output									
Voltage	Inverter mode: 220VAC±5%; AC mode: 220VAC±10%;								
Frequency (AC mode)	Auto-detect								
Frequency (inverter mode)	50Hz±1%								
Over Load Capacity (AC mode)	(100%~110%: 10min, 110%~130%: 1min, >130%: 1s)								
Over Load Capacity (inverter mode)	(100%~110%: 30s, 110%~130%: 10s, >130%: 1s)								
Crest Ratio	3:1 max								
Transfer Time	<10ms (typical loads)								
Waveform	Pure sine wave								
Efficiency	>85% (80%resistive loads)								
Protection Function	Battery overvoltage protection, battery undervoltage protection, overload protection, short circuit protection, overtemperature protection, etc.								
Cooling Method	Fans cooling								
Environmental Conditions									
Operation Temperature	0~40 °C (battery life decreases at ambient temperatures above 25 degrees Celsius)								
Operation Humidity	<95% without condensing								
Operation Altitude	<1000m (with increase of 100m, it will reduce output of 1%, max 5000m)								
Noise	<58dB (distance to machine 1m)								
Management									
Display	LCD+LED								
Communication Interface	RS232 (optional)								

Remarks: Specifications are subject to change without notice; Special voltage and power requirements can be customized designed

Product Model	LSOT1K-U1	LSOT1K-U2	LSOT2K-U2	LSOT2K-U4	LSOT3K-U2	LSOT3K-U4
Rated Power	1000W		2000W		3000W	
Battery Voltage	12V	24V	24V	48V	24V	48V
Size (W*D*H mm)	540x265x180					
Package Size (W*D*H mm)	580x310x220					
Net Weight (kg)	10.5		15		17.5	
Gross Weight (kg)	13		17.5		20	
Input						
Phase	L+N+G					
AC Input Range	110V: 85-138VAC					
Frequency	55Hz~65Hz					
Output						
Voltage	Inverter mode: 110VAC±5%; AC mode: 110VAC±10%;					
Frequency (AC mode)	Auto-detect					
Frequency (inverter mode)	60Hz±1%					
Over Load Capacity (AC mode)	(100%~110%: 10min, 110%~130%: 1min, >130%: 1s)					
Over Load Capacity (inverter mode)	(100%~110%: 30s, 110%~130%: 10s, >130%: 1s)					
Crest Ratio	3:1 max					
Transfer Time	<10ms (typical loads)					
Waveform	Pure sine wave					
Efficiency	>85% (80%resistive loads)					
Protection Function	Battery overvoltage protection, battery undervoltage protection, overload protection, short circuit protection, overtemperature protection, etc.					
Cooling Method	Fans cooling					
Environmental Conditions						
Operation Temperature	0~40 °C (battery life decreases at ambient temperatures above 25 degrees Celsius)					
Operation Humidity	<95% without condensing					
Operation Altitude	<1000m (with increase of 100m, it will reduce output of 1%, max 5000m)					
Noise	<58dB (distance to machine 1m)					
Management						
Display	LCD+LED					
Communication Interface	RS232 (optional)					

Remarks: Specifications are subject to change without notice; Special voltage and power requirements can be customized designed

Product Model	LSOT1K-D1	LSOT1K-D2	LSOT2K-D2	LSOT2K-D4	LSOT3K-D2	LSOT3K-D4
Rated Power	1000W		2000W		3000W	
Battery Voltage	12V	24V	24V	48V	24V	48V
Size (W*D*H mm)	540x265x180					
Package Size (W*D*H mm)	580x310x220					
Net Weight (kg)	10.5		15		17.5	
Gross Weight (kg)	13		17.5		20	
Input						
Phase	L+N+G					
AC Input Range	120V: 85-138VAC					
Frequency	55Hz~65Hz					
Output						
Voltage	Inverter mode: 120VAC±5%; AC mode: 120VAC±10%;					
Frequency (AC mode)	Auto-detect					
Frequency (inverter mode)	60Hz±1%					
Over Load Capacity (AC mode)	(100%~110%: 10min, 110%~130%: 1min, >130%: 1s)					
Over Load Capacity (inverter mode)	(100%~110%: 30s, 110%~130%: 10s, >130%: 1s)					
Crest Ratio	3:1 max					
Transfer Time	<10ms (typical loads)					
Waveform	Pure sine wave					
Efficiency	>85% (80%resistive loads)					
Protection Function	Battery overvoltage protection, battery undervoltage protection, overload protection, short circuit protection, overtemperature protection, etc.					
Cooling Method	Fans cooling					
Environmental Conditions						
Operation Temperature	0~40 °C (battery life decreases at ambient temperatures above 25 degrees Celsius)					
Operation Humidity	<95% without condensing					
Operation Altitude	<1000m (with increase of 100m, it will reduce output of 1%, max 5000m)					
Noise	<58dB (distance to machine 1m)					
Management						
Display	LCD+LED					
Communication Interface	RS232 (optional)					

Remarks: Specifications are subject to change without notice; Special voltage and power requirements can be customized designed



Residential Off-grid Inverter

Features

- The front and rear stage dual control chip and drive chip adopt the new imported intelligent control chip, better anti-interference ability, more stable and durable performance.
- The power device adopts the new imported IGBT-MOS tube, with guaranteed quality, stronger performance and stronger impact resistance.
- The heat dissipation effect of independent aluminum alloy radiator is better, so as to achieve the purpose of higher conversion efficiency.
- Heat dissipation fan adopts double ball high-speed fan for faster heat dissipation and longer service life.
- The transformer coil adopts a pure copper strip winding system, which ensures a high conversion efficiency.
- USB charging function of the device built-in fast charging protocol chip to improve the charging speed, and there is a built-in output over voltage protection circuit to protect our charging equipment.

Appearance

- Aluminum alloy shell, fireproof
- LED display
- One button switch
- QC2.0/5V USB interface
- AC socket

Product Model	LSOT300	LSOT600	LSOT1K	LSOT1K5	LSOT2K	LSOT2K5	LSOT3K
Output Power	300W	600W	1000W	1500W	2000W	2500W	3000W
Peak Power	600W	1200W	2000W	3000W	4000W	5000W	6000W
Input Voltage	12V/24V/48V/60V						
Output Voltage	100V/110V/120V/220V/230V/240V						
Output Frequency	50Hz/60Hz						
Output Wave	Pure sine wave						
Convert Efficiency	95%						
Dimensions	230×120×70mm	250×119×70mm	310×216×95mm	350×216×95mm	426×216×95mm	426×216×95mm	520×218×95mm
Voltage							
12V Series	Operating voltage range 9.5V-16V						
24V Series	Operating voltage range 20V-30V						
48V Series	Operating voltage range 40V-60V						
60V Series	Operating voltage range 48V-72V						

Remarks: Specifications are subject to change without notice.

Battery connection diagram

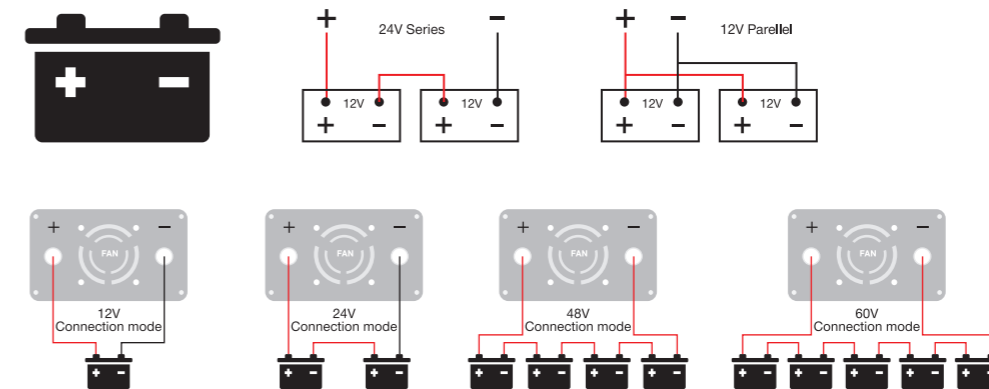

LESSO



Residential Off-grid Inverter With MPPT

Feature:

- Pure sine wave inverter
- Built-in MPPT solar charge controller
- Selectable charging current based on applications
- Configurable AC/Solar input priority via LCD setting
- Compatible to mains voltage or generator power

- Auto restart while AC is recovering
- Overload and short circuit protection
- Smart battery charger design for optimized battery performance
- Cold start function
- Parallel operation with up to 6 units (optional)

LESSO

Residential Off-grid Inverter with MPPT

Product Model	LSOTH3KTL-P2	LSOTH3K5TL-P2	LSOTH5KTL-P2	LSOTH5K5TL-P2	LSOTH6K2TL-P2	LSOTH8KTL-P2	LSOTH10KTL-P2	LSOTH11KTL-P2
Input sources	L+N+PE							
Rated input voltage	220/230/240VAC							
Voltage range	90-280VAC±3V (APP Mode) 170-280VAC±3V (UPS Mode)							
Frequency	50Hz/60Hz (Auto Adaptive)							
Rated power	3000W	3500W	5000W	5500W	6200W	8000W	10000W	11000W
Output voltage	220/230/240VAC±5%							
Output frequency	50/60Hz±0.1%							
Waveform	Pure Sine Wave							
Transfer time (adjustable)	Computers(UPS Mode)10ms , Appliance(APP Mode)20ms							
Peak power	6000W	7000W	10000W	11000W	12400W	16000W	20000W	22000W
Over load ability	Battery Mode:1min@102%~110%Load , 10s@110%~130%Load , 3s@130%~150%Load , 200ms@>150%Load							
Peak efficiency (battery Mode)	>94%	>94%	>94%	>94%	>98%	>98%	>98%	>98%
Battery voltage	24Vdc	24Vdc	48Vdc	48Vdc	48Vdc	48Vdc	48Vdc	48Vdc
Constant charging voltage	28.2Vdc	28.2Vdc	56.4Vdc	56.4Vdc	56.4Vdc	56.4Vdc	56.4Vdc	56.4Vdc
Floate charging voltage	27Vdc	27Vdc	54Vdc	54Vdc	54Vdc	54Vdc	54Vdc	54Vdc
PV charging mode	MPPT	MPPT	MPPT	MPPT	MPPT	MPPT Dual MPPT	MPPT Dual MPPT	MPPT Dual MPPT
Max PV input power	1500W	1500W	5500W	5500W	6200W	2*5500W	2*5500W	2*5500W
MPPT tracking range	30-145Vdc	30-145Vdc	120-500Vdc	120-500Vdc	120-500Vdc	90-500Vdc	90-500Vdc	90-500Vdc
Best voltage	30-115V	30-115V	300-400V	300-400V	300-400V	300-400V	300-400V	300-400V
Max PV input voltage	150Vdc	145Vdc	500Vdc	500Vdc	500Vdc	500Vdc	500Vdc	500Vdc
Max PV charging current	60A	60A	100A	100A	100A	150A	150A	150A
Max AC charging current	60A	60A	100A	100A	80A	120A	150A	120A
Max charging current	120A	120A	100A	100A	120A	150A	150A	160A
LCD display	Display running mode/loads/input/output etc.							
RS232	5Pin/pitch2.0mm , baud rate 2400							
Communication port	2x5Pin / pitch2.54mm , Lithium Battery BMS Communication Card , WifiCard, Dry Contact							
Parallel connect interface	Without parallel connect				With parallel (optional) ¹			
Operating temperature	-10-50°C							
Humidity	20%-95% (non-condensing)							
Storage temperature	-15-60°C							
Altitude	Altitude not over 1000m , derating over 1000m , max 4000m , refer to IEC62040							
Noise	≤50db							
Net weight	8.8kg		10.58kg			18.99kg		
Gross weight	10kg		11.96kg			22.25kg		
Product size	495x312x125mm				571x500x148mm			
Package size	552x385x193mm				708x570x241mm			

1: The parallel addition of inverters requires the addition of accessories and parallel boards. For more information, please contact the sales manager.

Remarks: Specifications are subject to change without notice. Special voltage and power requirements can be customized designed. The specific appearance is subject to the actual product.

Guangdong Lesso Energy Storage Technology Co., Ltd

Daba Industrial Area, Longjiang Town, Foshan City, Guangdong Province, China

LESSO Solar

energy@lessosolar.com www.lessosolar.com

LSOTH1-6KS-M01

Off-grid Inverter with MPPT

>>> Models:

- LSOTH1KS-M01
- LSOTH1K5S-M01
- LSOTH2KS-M01
- LSOTH3KS-M01
- LSOTH4KS-M01
- LSOTH5KS-M01
- LSOTH6KS-M01



Feature

- Split phase output
- Toroidal low-loss transformer, high inverter efficiency, pure sine wave output
- Intelligent LCD integrated display
- New appearance design, built-in photovoltaic MPPT controller
- Mains charging current is adjustable, allowing users to configure battery capacity more flexibly
- Three working modes can be set (AC mode, battery mode, energy saving mode)
- The startup peak power is more than 3 times, with fully automatic and complete protection functions
- Added fault code query function to facilitate users to monitor operating status in real time
- Supports diesel generators and can be used in harsh power environments
- Suitable for both industrial and residential scenarios, wall-mounted design, easy to install

Type	LSOTH1KS-M01	LSOTH1K5S-M01	LSOTH2KS-M01	LSOTH3KS-M01	LSOTH4KS-M01	LSOTH5KS-M01	LSOTH6KS-M01
Rated Power	1000W	1500W	2000W	3000W	4000W	5000W	6000W
Peak Power(20ms)	3000VA	4500VA	6000VA	9000VA	12000VA	15000VA	18000VA
Start Motor	1HP	1.5HP	2HP	3HP	3HP	4HP	4HP
Battery Voltage	12/24/48VDC			24/48VDC	24/48VDC	48VDC	
Max AC charging current	0~30A (Depending on model)						
Size(L*W*H:mm)	500x300x140				530x335x150		
Packing Size(L*W*H:mm)	565x395x225				605x420x235		
N.W.(kg)	12	13.5	18	20	22	24	26
G.W.(kg)	13.5	15	19.5	21.5	24	26	28
Installation Method	Wall-Mounted						
Input	DC Input Voltage Range	10.5-15VDC (Single battery voltage)					
	AC Input Voltage	110V /120AC or 220VAC/240AC					
	AC Input Voltage Range	85VAC~138VAC (110VAC) / 95VAC~148VAC (120VAC) / 170VAC~275VAC(220VAC) / 190VAC~295VAC(240VAC)					
	AC Input Frequency Range	45Hz~55Hz(50Hz) / 55Hz~65Hz(60Hz)					
	AC charging method	Three-stage (constant current, constant voltage, floating charge)					
Output	Efficiency(Battery Mode)	≥85%					
	Output Voltage(Battery Mode)	110VAC or 120VAC ; 220VAC or 240AC					
	Output Frequency(Battery Mode)	50/60Hz±1%					
	Output Wave(Battery Mode)	Pure Sine Wave					
	Efficiency(AC Mode)	≥99%					
Output	Output Voltage(AC Mode)	110VAC or 120VAC ; 220VAC or 240AC					
	Output Frequency(AC Mode)	Follow input					
	Output waveform distortion (Battery Mode)	≤3% (Linear load)					
	No load loss(Battery Mode)	≤0.8% rated power					
	No load loss(AC Mode)	≤0.8% rated power					
No load loss (Energy saving Mode)	≤10W						
Battery Type	VRLA Battery	Charge Voltage :14.2V; Float Voltage:13.8V (Single battery voltage)					
	Customize battery	Charging and discharging parameters of different types of batteries can be customized according to user requirements (charging and discharging parameters of different types of batteries can be set through the operation panel)					
Protection	Battery under voltage alarm , Battery under voltage protection , Battery over voltage alarm , Battery over voltage protection Battery over voltage recovery voltage , Overload power protection , Inverter output short circuit protection , Temperature protection(1)						
Alarm	A	Normal working condition, buzzer has no alarm sound					
	B	Buzzer sounds 4 times per second when battery failure, voltage abnormality, overload protection					
	C	When the machine is turned on for the first time, the buzzer will prompt 5 when the machine is normal					
Solar controller	Charging current	2V/24V:40A; 48V:30A	12V/24V:60A; 48V:30A	12V/24V:60A; 48V:30A	60A	24V:60A; 48V:60Aor100A	60Aor100A 160Aor100A
	PV Input Voltage Range	15V-120V(12V System); 30V-120V(24V System); 60V-120V(48V System)					
	Max PV Input Voltage(Voc) (At the lowest temperature)	150V					
	PV Array Maximum Power	12V System: 560W (40A)/840W(60A); 24V System: 1120W(40A)/1680W(60A); 48V System: 1680W(30A)/3360W(60A)/5600W(100A)					
	Standby loss	≤3W					
Maximum conversion efficiency	>95%						
Working Mode	Battery First/AC First/Saving Energy Mode (Can be set)						
Transfer Time	≤4ms						
Display	LCD						
Thermal method	Cooling fan in intelligent control						
Communication	RS485/APP (WIFI monitoring or GPRS monitoring)						
Environment	Operating temperature	-10°C~40°C					
	Storage temperature	-15°C~60°C					
	Noise	≤55dB					
	Elevation	2000m (More than derating)					
	Humidity	0%~95% ,No condensation					

Note: All specifications are subject to change without prior notice

LESSO



Residential Off-grid Inverter With MPPT

(Single Phase Power Frequency)

Models:

- LSOTH1KL LSOTH6KL
- LSOTH2KL LSOTH8KL
- LSOTH3KL LSOTH10KL
- LSOTH4KL LSOTH12KL
- LSOTH5KL



LESSO

Residential Off-grid Inverter with MPPT

(Single Phase Power Frequency)

Product Model	LSOTH1KL	LSOTH2KL	LSOTH3KL	LSOTH4KL	LSOTH5KL	LSOTH6KL	LSOTH8KL	LSOTH10KL	LSOTH12KL	
Rated Power	1kW	2kW	3kW	4kW	5kW	6kW	8kW	10kW	12kW	
Max. Power	3kW	6kW	9kW	12kW	15kW	18kW	24kW	30kW	36kW	
Rated Battery Voltage	12/24/48V	12/24/48V	12/24/48V	24/48V	24/48V	24/48V	48V	48V	48V	
MPPT Control Module	Charge Current	60A	80A	80A	80A	80A	80A	80A	80A	
	PV Module Input	1 circuit (80A)								
	PV Input Operating Voltage	15V-180V (12V System) ;30V-180V (24V System) ; 60V-230V (48V System)								
	Maximum PV Array Power	60A: 720W(12V System) 1440W(24V System) ; 3840W (48V System) ;								
	Max. Charge Current (Adjustable)	OFF/30A/60A								
	Control Module Efficiency	≈99%								
	Unattended mode	MPPT Control Module continues to charge battery from PV module even when device is switched off								
Input	DC Input Voltage Range	10.5VDC-15VDC (12V voltage unit) (lead acid battery)								
	Mains AC Input Voltage Range	110Vac: (80-130)Vac; 220Vac: (160-260)Vac/(130-280)Vac (Adjustable)								
	Mains AC Input Frequency	45HZ-65HZ automatic match								
	Mains AC Charge Current (Adjustable)	ON/OFF (Adjustable)								
Output	Inverter output voltage waveform	Pure sine wave								
	Inverter output Efficiency	≈90%								
	Inverter output voltage	200V/210V/220V/230V/240V (Adjustable)								
	Inverter output Frequency	50Hz/60Hz (Adjustable)								
	AC output voltage	110VAC±10%/220VAC±10%								
	AC output Frequency	Automatic tracking								
Operating Mode	Inverter operating mode	Mains AC priority mode, battery priority mode, ECO mode, unattended mode, power generation mode								
	Battery Parameter	Supported battery type: Lead acid battery / LiFePO ₄ battery / NiCoMn battery / Gel battery / Customer self-defined								
Protection	Battery defining parameter	Constant-voltage charging setting, float-voltage charging setting, battery recovery voltage setting, mains AC recovery voltage setting, low voltage alarm setting, low voltage protection setting								
	Battery charging mode	Lead acid battery: constant current, constant voltage, float charging LiFePO ₄ battery: constant current, constant voltage								
	Lithium type battery selection	LiFePO ₄ battery: 3.2V per unit NiCoMn battery: 3.7V per unit								
Display	System Protection	Battery low voltage protection / Battery high voltage protection / Overload protection / Over heating protection,etc								
	LCD display	Mains AC status, DC-AC status, charging status, alarm								
	Operating display	Operating status, Input & output voltage, PV module operating information, Inverter operating information and etc.								
Switch Time	Language	English/Chinese (Adjustable)								
	Switch Time	< 5ms								
	Cooling Method	Smart temperature control system								
	Communication	RS232/RS485 (optional)								
	Operating Temperature	(-10℃~40℃)								
	Operating Altitude	≤3000m								
	Product Dimensions	495*320*220mm				560*390*200mm				
	Package Dimensions	600*380*290mm				715*420*316mm				
	Net Weight (kg) (Approx)	11kg	16.5kg	19.5kg	22kg	25kg	28kg	31.5kg	36kg	40kg
	Gross Weight (kg) (with wooden crate) (Approx)	14kg	19.5kg	22kg	25kg	28kg	31kg	36kg	41kg	45kg

Remarks: Specifications are subject to change without notice; Special voltage and power requirements can be customized designed

Guangdong Lesso Energy Storage Technology Co., Ltd

Daba Industrial Area, Longjiang Town, Foshan City, Guangdong Province, China

LESSO Solar

energy@lessosolar.com www.lessosolar.com

LESSO



MPPT Solar Charge Controller

>> Models:

- LSSM30A LSSM80A
- LSSM40A LSSM100A
- LSSM60A

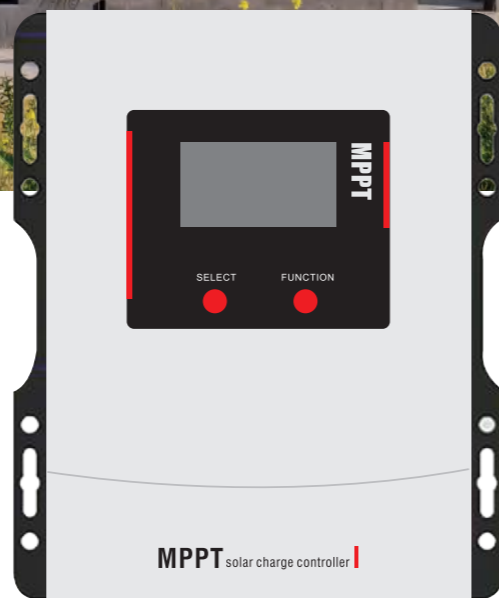

LESSO MPPT Solar Charge Controller

MPPT Model	LSSM30A	LSSM40A	LSSM60A	LSSM80A	LSSM100A
System rated voltage	12/24/36/48VDC or self-identification				
Controller operating voltage range	12~64V				
Lead-acid battery type	Maintenance-free (default)/colloid/liquid/custom				
Lithium battery type	Lithium Iron Phosphate/Ternary Lithium/Custom				
Rated charging current	30A	40A	60A	80A	100A
Rated charging power	390W/12V	550W/12V	800W/12V	1040W/12V	1300W/12V
	780W/24V	1100W/24V	1600W/24V	2080W/24V	2600W/24V
	1170W/36V	1650W/36V	2400W/36V	3120W/36V	3900W/36V
	1560W/48V	2200W/48V	3200W/48V	4160W/48V	5200W/48V
Maximum open circuit voltage of photovoltaic modules	150V (under the lowest temperature condition) 138V (under 25°C condition)				
Maximum power point operating voltage range	12V system	20~150VDC		20~150VDC	
	24V system	36~150VDC		36~150VDC	
	36V system	48~150VDC		48~150VDC	
	48V system	54~150VDC		64~150VDC	
Tracking efficiency	≥99.5%				
Maximum conversion efficiency	97.5%		98%		
Temperature compensation coefficient	-3mV/°C/2V				
Static loss	200mA/12V; 100mA/24V; 50mA/48V;	350mA/12V; 170mA/24V; 84mA/48V;	700mA/12V; 350mA/24V; 175mA/48V;		
DC load output voltage	Can be turned on in 12/24V mode				
DC load rated output current	20A		40A		
DC load output control	Normally open normally closed mode/time control mode/light control mode				
Protective function	PV input reverse connection protection, battery input reverse connection protection, battery overcharge protection, battery undervoltage protection, battery over temperature protection, machine over temperature protection				
Cooling method	Wind cooling				
Way of communication	RS485				
LCD backlight time	Default 60S, backlight mode can be set				
Working environment temperature range	-20°C~+50°C				
Storage temperature range	-40°C~+70°C				
Relative humidity range	0~90%RH				
Dimensions	210*150*80mm	219*260*110mm	219*260*110mm	275*348*109mm	275*348*109mm
Recommended wiring	9AWG/6mm ²	7AWG/10mm ²	6AWG/16mm ²	4AWG/25mm ²	2AWG/35mm ²
Net weight	1.45kg	2.62kg	2.62kg	4.6kg	5.2kg

Remarks: Specifications are subject to change without notice.

Guangdong Lesso Energy Storage Technology Co., Ltd

Daba Industrial Area, Longjiang Town, Foshan City, Guangdong Province, China

LESSO Solar

energy@lessosolar.com www.lessosolar.com

LESSO



MPPT Solar Charge Controller

>> Models:

LSSM40A-A01

LSSM80A-A01

LSSM60A-A01

LSSM100A-A01

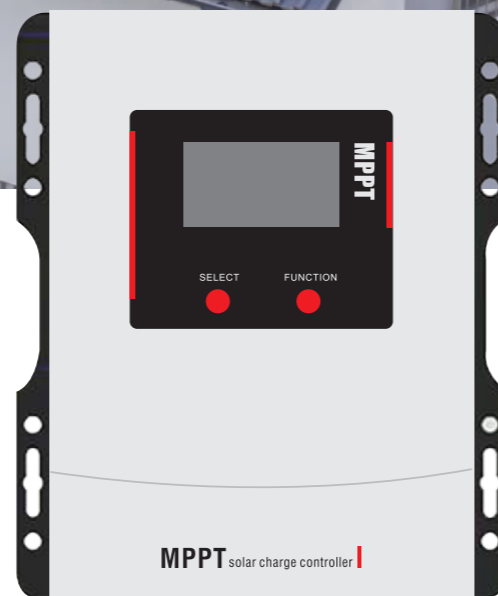

LESSO MPPT Solar Charge Controller

MPPT Model	LSSM40A-A01	LSSM60A-A01	LSSM80A-A01	LSSM100A-A01
System rated voltage	96VDC			
Controller operating voltage range	72~128V			
Lead-acid battery type	Maintenance-free (default)/colloid/liquid/custom			
Lithium battery type	Lithium Iron Phosphate/Ternary Lithium/Custom			
Rated charging current	40A	60A	80A	100A
Rated charging power	4160W/96V	6240W/96V	8320W/96V	10400W/96V
Maximum open circuit voltage of photovoltaic modules	250V (under the lowest temperature condition) 225V (under 25°C)			
Maximum power point operating voltage range	12V system	(96V system)128~250VDC		
	24V system			
	36V system			
	48V system			
Tracking efficiency	≥99.5%			
Maximum conversion efficiency	98%			
Temperature compensation coefficient	-3mV/°C/2V			
Static loss	40mA/96V		83mA/96V	
Protective function	PV input reverse connection protection, battery input reverse connection protection, battery overcharge protection, battery undervoltage protection, battery over temperature protection, machine over temperature protection			
Cooling method	Wind cooling			
Way of communication	RS485			
LCD backlight time	Default 60S, backlight mode can be set			
Working environment temperature range	-20°C~+50°C			
Storage temperature range	-40°C~+70°C			
Relative humidity range	0~90%RH			
Dimensions	219*260*110mm	219*260*110mm	275*348*109mm	275*348*109mm
Recommended wiring	7AWG/10mm ²	6AWG/16mm ²	4AWG/25mm ²	2AWG/35mm ²
Net weight	2.62kg	2.62kg	4.6kg	5.2kg

Remarks: Specifications are subject to change without notice.

Guangdong Lesso Energy Storage Technology Co., Ltd

Daba Industrial Area, Longjiang Town, Foshan City, Guangdong Province, China

LESSO Solar

energy@lessosolar.com www.lessosolar.com



Residential Hybrid Inverter

Split-Phase Hybrid Inverter

Battery Low Voltage

Key strengths

- Plug & Play.
- Capable of supporting 100% unbalanced loads.
- 3 phase 208Vac & paralel function available.
- 100A pass through.
- AC couple to retrofit existing solar system(on-grid & off-grid).
- Grid & diesel Generator separately connected, support storing energy from diesel generator.

Type	LSRTH5KTLS-ML01	LSRTH6KTLS-ML01	LSRTH7K6TLS-ML01	LSRTH8KTLS-ML01	LSRTH10KTLS-ML01
------	-----------------	-----------------	------------------	-----------------	------------------

PV input

Max.DC input power (kW)	7.5	9	12	12	15
No. of MPPT trackers			4		
MPPT voltage range (V)			120~500		
MAX.DC input voltage (V)			500		
MAX. input current (A)			14		
MAX. short circuit current (A)			22		

Battery input

Nominal voltage (V)			48		
MAX.charging/discharging current (A)	120/120	135/135	190/190	190/190	190/210
Battery voltage range (V)			40~60		
Battery type			Lithium /Lead-acid		
Charging strategy for Li-Ion battery			Self-adaption to BMS		

Type	LSRTH5KTLS-ML01	LSRTH6KTLS-ML01	LSRTH7K6TLS-ML01	LSRTH8KTLS-ML01	LSRTH10KTLS-ML01
------	-----------------	-----------------	------------------	-----------------	------------------

AC output(on-grid)

Nominal output power output to grid (kVA)	5	6	7.6	8	10
MAX. apparent power output to grid (kVA)	5.5	6.6	8.4	8.8	11
Output voltage range (V)	(110~120)/(220~240)split phase, 240V single phase				
Output frequency (Hz)	60(55 to 65)				
Nominal AC current output to grid (A)	20.8	25	31.7	33.3	41.7
Max. AC current output to grid (A)	22.9	27.5	34.8	36.7	45.8
Max. grid passthrough current (A)	100				
Output THDi	<3%				

AC output(back-up)

Nominal. apparent power (kVA)	5	6	7.6	8	10
Max. apparent power (kVA)	5.5	6.6	8.4	8.8	11
Nominal output voltage L-N/L1-L2 (V)	120/240				
Nominal output frequency (Hz)	60				
Automatic switchover time (ms)	<20				
Output power factor	0.8leading~0.8lagging				
Output THDu	<2%				

Protection

Grounding detection	Yes
Arc fault protection	Yes
Island protection	Yes
Battery reverse polarity	Yes
Insulation resistor detection	Yes
Residual current monitoring unit	Yes
Output over current protection	Yes
Back-up output short protection	Yes
Output over voltage protection	Yes
Output under voltage protection	Yes

General data

Mppt efficiency	99.9%
Europe efficiency (PV)	96.5%
PV to grid efficiency (PV)	97.2%
Battery to load efficiency	95.2%
PV to battery charging efficiency	96.1%
Grid to battery charging efficiency	95.0%
Output conduit (mm)	25.4
PV input conduit (mm)	25.4
BAT input conduit (mm)	35.4
Operating temperature range (C)	-25~+60
Relative humidity	0-95%
Operating altitude	0~4,000m(Derating above 2,000m altitude)
Ingress protection	IP65/NEMA 3R
Built-in breaker	Optional
Weight (kg)	48kg(50kg with breaker)
Dimensions W*H*D (mm)	450 x 820 x 240
Cooling	FAN cooling
Noise emission (dB)	38
Display	LCD,Touch panel(optional)
Communication with BMS/Meter/EMS	RS485, CAN
Supported communication interface	RS485, WLAN, 4G (optional)
Self-consumption	<25W
Safety	UL1741SA all options, UL1699B, CSA 22.2
EMC	FCC part 15 class B
Support diesel generator	YES

Other data

Peak power (off grid)	105%,60s / 110%,30s / 120%,10s / 150%,20ms
-----------------------	--

LSRTH Series Residential Hybrid Inverter (Single Phase)



Product Highlights

Safe and reliable

- Passed IEC/EN62109-1/-2, IEC/EN62477-1 South Africa NRS097-2-1; 2017, IEC/EN 61000-6-1 IEC/EN 61000-6-3 test certification

User-friendly and flexible

- Support multiple parallel connection
- Support connection with diesel generator
- Compatible with lead-acid and lithium-iron battery

Economical

- Intelligent EMS management function
- Automatic on/off grid switching to ensure important loads operating during the grid network blackout



	LSRTH 3KTLL	LSRTH 3K6TLL	LSRTH 4KTLL	LSRTH 4K6TLL	LSRTH 5KTLL	LSRTH 6KTLL
Input Parameter (PV)						
Max. Input Power (kW)	4.6	4.6	6	6	7	7
Max. Input Voltage (V)	550					
MPPT Voltage Range (V)	125 - 500					
Max. Current per MPPT (A)	14					
Number of MPPT / Number of String per MPPT	2/1					
Output Parameter (AC)						
Rated Output Power (kVA)	3	3.68	4	4.6	5	6
Max. Output Current (A)	13	16	17.4	20	21.7	26
Grid Voltage Range (V)	230 (176~270)					
Rated Grid Frequency (Hz)	50/60					
Power factor	0.99 leading~0.99 lagging					
THDi	< 2%					
Grid Type	L+N+PE					
Battery Parameter						
Battery Voltage Range (V)	40~58					
Max. Charging Voltage (V)	58					
Max. Charging/Discharging Current (A)	95/62.5	95/76.6	95/83.3	95/95.8	95/104.2	95/110
Battery Type	Lithium iron phosphate battery / Lead acid battery					
Communication	CAN, RS485					
Emergency AC Power Supply (EPS)						
220-240 / 110-120 (Connect to split-phase transformer)						
Rated Output Power (kVA)	3	3.68	4	4.6	5	6
Rated Output Voltage (V)	230					
Rated Output Current (A)	13	16	17.4	20	21.7	26
Rated Output Frequency (Hz)	50 / 60					
Automatic Switch Time (ms)	< 20					
THDu	< 2%					
Overload Capacity	110%, 30S / 120%, 10S / 150%, 0.02S					
Normal Parameter						
Battery Charging/Discharging	95.0%					
Efficiency	97.6%					
Max. Efficiency	97.0%					
MPPT Efficiency	99.9%					
Protection Degree	IP65					
Noise (dB)	< 35					
Operating Temperature Range	-25 C ~60 C					
Cooling Method	Natural cooling					
Relative Humidity	0~95% non-condensing					
Max. Operating Altitude	No limit below 2000m					
Dimensions of product / packaging (mm)	550* 200* 520 / 680*660*330					
Net weight / Gross weight (kg)	25 / 31					
Transformerless Topology	No					
Night Power Consumption	< 3					
Screen & Communication						
Screen	LCD					
Communication	Standard / Optional / Optional / Standard / Standard					
Safety	IEC / EN62109-1 / -2, IEC / EN62477-1					
EMC	IEC / EN 61000-6-1 IEC / EN 61000-6-3					
Grid Connection Standards	South Africa NRS097-2-1: 2017,UK/G98,G99					

LSRTH Series Residential Hybrid Inverter (Three Phase)



Product Highlights

Safe and reliable

- Anti-islanding protection, PV reverse polarity protection, battery reverse polarity protection, insulation resistance monitoring, residual current monitoring, AC overcurrent protection, AC overload protection, short circuit protection

User-friendly and flexible

- Support connection with diesel generator
- Full power discharge and automatic management of battery charge and discharge;
- Natural cooling design with very low noise

Economical

- Support multiple operation mode for better ROI
- UPS mode to guarantee critical loads during power grid blackout



Basic Parameters

Type	LSRTH 6KTL3L	LSRTH 8KTL3L	LSRTH 10KTL3L	LSRTH 12KTL3L	LSRTH 15KTL3L
Protection Degree	IP65				
Operating Temperature Range	-35~60°C				
Relative Humidity	0~100%				
Max. Operating Altitude	4000m (Limit over 2000m)				
Cooling Method	Natural cooling				
Noise(dB)	≤25dB				
Installation Mode	Wall mounted				
EMC	IEC/EN 61000-6-1:2019, IEC/EN 61000-6-2:2019, IEC/EN 61000-6-3:2021, IEN/EN 61000-6-4:2019, IEC/EN 61000-3-2:2019/A1:2021, EN 61000-3-3:2013/A2:2021, IEC/EN 61000-3-11:2019, EN 61000-3-12:2011				
Grid Connection Standards	Europe: EN 50549-1:2019/AC:2019; Poland: EN50549-1:2019/Rfg:2016/NC Rfg:2018/PTPIREE:2021; Germany: VDE-AR-N 4105:2018/DIN VDE V 0124-100(VDE V 0124-100):2020; South Africa: NRS 097-2-1:2017 Edition 2.1; GB: G99/1-6:2020; Spain: UNE217001:2020/UNE217002:2020/NTS V2.1:2021-07, IEC61727:2004/IEC62116:2014/IEC61683:1999; Hungary: EN50549-1:2019/RFG:2016/Hungary				
Safety standard	IEC / EN62109-1:2010, IEC / EN62109-2:2011				

Interface Parameter

Type	LSRTH 6KTL3L	LSRTH 8KTL3L	LSRTH 10KTL3L	LSRTH 12KTL3L	LSRTH 15KTL3L
Interface	LCD; APP				
BMS Connection	RS485, CAN				
EMS Connection	RS485				
Meter Communication Interface	RS485				
Communication Interface	WIFI / GPRS / 4G				

Battery Parameter

Type	LSRTH 6KTL3L	LSRTH 8KTL3L	LSRTH 10KTL3L	LSRTH 12KTL3L	LSRTH 15KTL3L
Max. Charging/Discharging Power	6600W	8800W	11000W	13200W	16500W
Battery Voltage Range(V)	125~600V				
Battery Operation Voltage Range(V)	150~550V				
Max. Charging/Discharging Current(A)	50A				
Rated Charging/Discharging Current(A)	40A				
Battery Type	LiFePO ₄ / Lead acid battery				

Input Parameter (PV)

Type	LSRTH 6KTL3L	LSRTH 8KTL3L	LSRTH 10KTL3L	LSRTH 12KTL3L	LSRTH 15KTL3L
Max. Input Power	9000W	12000W	15000W	18000W	22500W
Max. Input Voltage	1000V				
MPPT Voltage Range	180~850V				
FullLoad MPPT Voltage Range	250V~850V	330V~850V	430V~850V	510V~850V	620V~850V
Start Voltage	125V				
Max. Current per MPPT	13/13A	13/13A	13/13A	13/13A	20/20A
Max. Short Circuit Current	16/16A	16/16A	16/16A	16/16A	30/30A
Number of MPP Trackers	2				
Number of MPPT / Number of String per MPPT	1/1	1/1	1/1	1/1	2/2
Rated Input Voltage	600V				

Output Parameter (Grid AC)

Type	LSRTH 6KTL3L	LSRTH 8KTL3L	LSRTH 10KTL3L	LSRTH 12KTL3L	LSRTH 15KTL3L
Rated Output Power	6000VA	8000VA	10000VA	12000VA	15000VA
Max. Output Power	6600VA	8800VA	11000VA	13200VA	16500VA
Max. Input Grid Power	13200VA	17600VA	22000VA	26400VA	33000VA
Max. Input Grid Current	19.1A	25A	31.8A	38.1A	47.6A
Rated Output Current	8.7A	11.5A	14.4A	17.3A	21.7A
Max. Output Current	9.5A	12.7A	15.9A	19.1A	23.8A
Rated Grid Voltage	380V/400V, 3W+N+PE				
Rated Grid Frequency	50Hz / 60Hz				
THDI	< 2%				

Emergency AC Power Supply (EPS) Parameter

Type	LSRTH 6KTL3L	LSRTH 8KTL3L	LSRTH 10KTL3L	LSRTH 12KTL3L	LSRTH 15KTL3L
Rated Output Power	8000VA	8000VA	10000VA	12000VA	15000VA
Max. Output Power	8800VA	8800VA	11000VA	13200VA	16500VA
Rated Output Current	8.7A	11.5A	14.4A	17.3A	21.7A
Max. Output Current	9.5A	12.7A	15.9A	19.1A	23.8A
Rated Output Voltage	400V,3W+N+PE				
Rated Output Frequency	50Hz/60Hz				
THDu	< 2%				
Max. Efficiency	97.9%	97.9%	98.2%	98.2%	98.5%
European Efficiency	97.2%	97.2%	97.5%	97.5%	97.6%
MPPT Efficiency	99.9%				
Max. Battery Charging / discharging Efficiency	97.5%	97.5%	97.5%	97.6%	97.8%

Mechanical Parameter

Type	LSRTH 6KTL3L	LSRTH 8KTL3L	LSRTH 10KTL3L	LSRTH 12KTL3L	LSRTH 15KTL3L
Dimensions of product / packaging	530*200*560 / 660*330*720mm				
Weight	30kg	30kg	31kg	32kg	34kg

Batteries series

Light Up Every Household





LSMO 25.6V(120-200)AH Battery Module

LSMO Battery Module be mainly used in electric vehicles, electric mobility; Solar/wind energy storage system; UPS, backup power; Telecommunication; Medical equipment; Lighting.

Features



Longer Cycle Life

life than lead acid battery, helping to minimize replacement cost and reduce total cost of owner.



Lighter Weight

About 40% of the weight of a comparable lead acid battery. A 'drop in' replacement for lead acid batteries.



Higher Power

Delivers twice power of lead acid battery, even high discharge rate, while maintaining high energy capacity.



Superior Safety

Automatic protection with internal battery management system.



Increased Flexibility

Modular design enables deployment of up to two batteries in series and up to four batteries in parallel.



Wider Temperature Range

-20°C~60°C

Items	LSMO 25.6V120AH	LSMO 25.6V120AH-ZY	LSMO 25.6V200AH-A01
Nominal voltage	25.6V		
Voltage range	25.6V~26.4V		
Nominal capacity	120Ah	120Ah	200Ah
Minimum capacity	120Ah	120Ah	200Ah
Initial impedance	≤180mΩ		
Charge limit voltage	28.8V		
Discharge cut-off voltage	18.4V		
Standard charge current	50A		
Maximum charge current	100A		
Standard discharge current	50A		
Max continuous discharge current	100A		
Charging time	Standard charging: 2~3 hours Rapid charge: 1~2 hours		
Cycle Life	120-125Ah: ≥4000 Cycle life; 200Ah: ≥6000 Cycle life Test condition: Charge: 0.2C to 28.8V/Cell, then stored for 10 minutes. Discharge: 0.5C to over discharge protection, then stored for 10 minutes. When the discharge capacity drops to 80% of the initial capacity, the number of cycles completed is defined as the cycle life of the energy storage.		
Operating temperature	Charging temperature: 0°C~55°C Discharging temperature: -20°C~55°C		
Storage temperature	0°C~+45°C (<1 month) 0°C~+35°C (<6 month)		
Storage humidity	<75% RH		
Standard testing condition	Temperature: 25±2°C Humidity: ≤75%RH		
Product dimension	522*238*218mm		
Weight	≈ 25kg	≈ 25kg	≈ 35kg

Remarks: Specifications are subject to change without notice.



LSRW51V100AH-LFP

Residential Wall-mounted Energy Storage

LSRW series battery packs are wall-mounted residential lithium batteries, designed entirely for residential ESS applications. With our battery technology, you can easily combine it with a mainstream inverter in different scenarios to save your electrical bill & back-up your power during grid outage or unavailable.

Features



Safety

High safety LiFePO₄ battery; Fire-safe, non-toxic; Lithium ferrous phosphate (LFP) cells. Meet UL1973, IEC62619 UN38.3 certification



Long-lasting

15 years life design. Long cycle life and superior performance



Flexible

Long cycle life (>6000cycles@ 80% DOD) Wall mounted



Wide compatibility

Compatible with multiple brands of mainstream inverter use



Environment protection

Non-toxic and pollution-free



Smart WiFi

Support wifi APP and cloud platform monitor



LESSO

Residential Wall-Mounted Energy Storage

Items	LSRW51V100AH-LFP
Nominal voltage	51.2V
Nominal capacity	100Ah
Nominal energy	5.12kWh
Usable energy	5.0kWh
Recommended charge current	50A
Max. continuous charge current	80A
Max. continuous discharge current	80A
Peak discharge current	300A/3s
Max. continuous discharge power	5kW
Peak discharge power	15kW/3s
Self-discharge rate (Sleep mode)	Capacity: ≤ 3% / month; ≤ 20% / years
Standard charge voltage	56.0V
Floating charge voltage	54.0V
End of discharge voltage	43.2V
Communication	RS485 / CAN
IP rating	IP55
Cycle life	≥ 6000 cycles @80%DOD
Net weight	60.7kg
Dimension of product (L*W*H)	454*170*698mm
Dimension of packaging (L*W*H)	558*407*768mm
Battery housing	SGCC with white coating
Operation temperature	0~45°C (32~113°F)
Recommended operation temperature	15~30°C (59~86°F)
Storage temperature for short time	-10~45°C (14~113°F)
Storage temperature for long time	10~35°C (50~95°F)
Operation humidity	5~95%
Install altitude	≤ 4000m
Install location	Under the roof
Installation	Wall mounted
Certification	CE / IEC62619 / UL1973 / UN38.3



Residential Wall-mounted Energy Storage



Flexible

Scalable battery design for easy expansion, Max. 16pc



Safe & Reliable

BYD blade lithium cell. More Safety, longer life cycle and more usable energy, upto to more than 10 years working life



Easy Installation

Stylish, ultra-thin. Easy connection, saving installation time and cost



Perfect Compatibility

Compatible to residential 48V hybrid inverter and off grid inverter. Compatible with CAN / RS485 communication interface. Matching with leading inverter brands

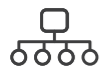

Application scenario

Villa, household, farm, base station, field power supply

Product Model	LSRW51V120AH-LFP-B1
Battery type	BYD blade lithium-iron phosphate (LiFePO ₄)
Battery energy	6.144kWh
Nominal voltage	51.2V
Nominal capacity	120Ah
Operating voltage range	43.2V-57.6V
Standard charging mode	Constant current charging (CC)
Standard charging current	30A @ 25°C
Max. constant charging current	120A @ 25°C
Charge limit voltage	60.8V
Standard discharging mode	Constant current discharging (CC)
Standard discharging current	30A @ 25°C
Max. discharging current	120A @ 25°C
Discharge cut-off voltage	32V
Scalability	Max. 16 strings in parallel
Depth of discharge	80%
Design life	>10 years (25°C/77°F)
Protection	Over-temperature, over charge, under-voltage, over-current, short circuit alarm functions
Display	LED indicator
Communication	CAN / RS485
Dimension (W*D*H)	1078*140*437mm
Weight	76.9kg
Installation	Wall mount
Shipping status SOC	20% ~ 30%
Charging temperature	-20 ~ +55°C
Discharging temperature	-30 ~ +60°C
Short term storage ambient temperature	-20 ~ +35°C (<3 months, 20 ~ 60% SOC)
Long term storage ambient temperature	20 ~ +30C (< 1 year, 30 ~ 60% SOC)
Max.operating altitude	4000m (derating above 2,000m)
Protection degree	IP21, indoor installation
Relative humidity	5% ~ 95%
Cooling	Natural cooling
Noise emission	<29db
Certificate	CE, UN38.3

Remarks: Specifications are subject to change without notice; Special voltage and power requirements can be customized designed

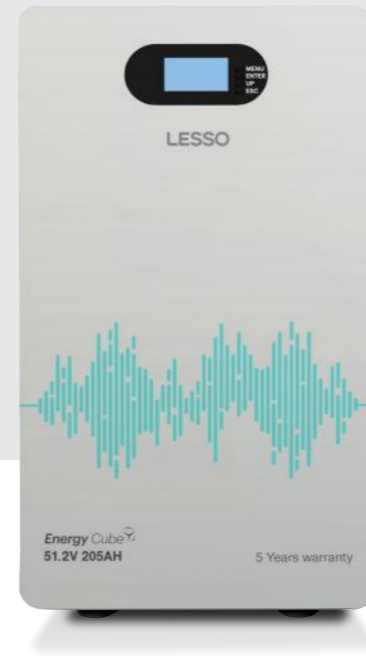

Residential Wall-mounted Energy Storage

LSRW series battery packs are wall-mounted residential lithium batteries, designed entirely for residential ESS applications. With our battery technology, you can easily combine it with a mainstream inverter in different scenarios to save your electrical bill & back-up your power during grid outage or unavailable.

Features



Safety

High safety LiFePO₄ battery; Fire-safe, non-toxic; Lithium ferrous phosphate (LFP) cells.



Long-lasting

10 years life design. Long cycle life and superior performance



Portable installation

Wall-mounted installation method, does not occupy ground space.



Wide compatibility

Compatible with multiple brands of mainstream inverter use



Environment protection

Non-toxic and pollution-free

Items	LSRW51V205AH-LFP
Nominal voltage	51.2V
Nominal capacity	205Ah
Nominal energy	10.49kWh
Usable energy	10kWh
Recommended charge current	100A
Max. continuous charge current	120A
Max. continuous discharge current	150A
Max. continuous discharge power	7.6kW
Self-discharge rate (Sleep mode)	Capacity: ≤ 3.5% / month
Standard charge voltage	56.0V
End of discharge voltage	40V
Communication	RS485 / CAN
IP rating	IP55
Cycle life	≥ 6000 cycles @90%DOD
Net weight	86.5kg
Dimension of product (L*W*H)	700*400*240mm
Battery housing	SGCC with white coating
Operation temperature	0~60°C (32~140°F)
Recommended operation temperature	15~30°C (59~86°F)
Storage temperature for short time	-10~45°C (14~113°F)
Storage temperature for long time	10~35°C (50~95°F)
Operation humidity	5~95%
Install altitude	≤ 4000m
Install location	Under the roof
Installation	Wall mounted, Floor standing
Certification	UN38.3 / MSDS



Residential Wall-mounted Energy Storage

LSRW series battery packs are wall-mounted residential lithium batteries, designed entirely for residential ESS applications. With our battery technology, you can easily combine it with a mainstream inverter in different scenarios to save your electrical bill & back-up your power during grid outage or unavailable.

Features



Safety

High safety LiFePO₄ battery; Fire-safe, non-toxic; Lithium ferrous phosphate (LFP) cells.



Long-lasting

10 years life design. Long cycle life and superior performance



Portable installation

Wall mounted installation method, wheeled mobility.



Wide compatibility

Compatible with multiple brands of mainstream inverter use



Environment protection

Non-toxic and pollution-free

Items	LSRW51V280AH-LFP
Nominal voltage	51.2V
Nominal capacity	280Ah
Nominal energy	14.3kWh
Usable energy	14kWh
Recommended charge current	140A
Max. continuous charge current	200A
Max. continuous discharge current	200A
Max. continuous discharge power	10kW
Self-discharge rate (Sleep mode)	Capacity: ≤ 3% / month
Standard charge voltage	56.0V
End of discharge voltage	40V
Communication	RS485 / CAN
IP rating	IP55
Cycle life	≥ 6000 cycles @90%DOD
Net weight	122kg
Dimension of product (L*W*H)	700*600*248mm
Battery housing	SGCC with white coating
Operation temperature	0~60°C (32~140°F)
Recommended operation temperature	15~30°C (59~86°F)
Storage temperature for short time	-10~45°C (14~113°F)
Storage temperature for long time	10~35°C (50~95°F)
Operation humidity	5~95%
Install altitude	≤ 4000m
Install location	Floor standing
Certification	UN38.3 / MSDS

LESSO



LSRR51V100AH-LFP Residential Rack Energy Storage

LSRR series battery packs are rack type residential lithium batteries, designed entirely for residential ESS applications. With our battery technology, you can easily combine it with any mainstream inverter in different scenarios to reduce your electrical bill & back-up your power during grid outage or when power is unavailable



Modular

Support up to 32 units in parallel, scale from 5 kWh to 160 kWh configuration without external controller



4 types of installation

Compact & Flexible. 3U (133mm) standard height design. Optional bracket kits for different installation scenarios.



Wall mounted

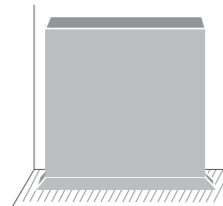

Floor mounted

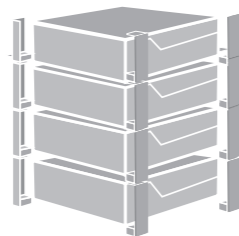

Rack mounted



Stack

CE UK CA UN38.3

LESSO

Residential Rack Energy Storage

Items	LSRR51V100AH-LFP
Nominal voltage	51.2V
Nominal capacity	100Ah
Nominal energy	5.12kWh
Usable energy	4.92kWh
Operating voltage range	44.8V~56.0V
Charge voltage	56V
Float voltage	54.6V
Recommended charge current	50A
Max. charge current	70A
Recommended discharge current	50A
Max. discharge current	100A
Communication	RS485 /CAN
Peak discharge current / unit	101~119A@5mins 120~149A@15S
IP rating	IP20
Cycle life	≥ 6000 cycles @90%DOD
Net weight / unit	47kg
Gross weight / unit	50kg
Dimension of product / unit	482*133.5*460mm
Dimension of packaging / unit	574*217*526mm
Cell type	Lithium-iron phosphate (LiFePO ₄)
Design life	15 years
Operation temperature	-10~50°C (14~122°F)
Storage temperature	-10~45°C(14~113°F)
Relative humidity	5% - 90%, No condensation
Install altitude	≤ 4000m
Install location	Indoor
Installation	Wall mounted / Floor mounted / Stack / Rack mounted
Certification	CE / IEC62619 / UL1973 / UN38.3

[1] Test conditions: 90% depth of discharge (DOD), 0.2C rate charge & discharge at 25°C

[2] Available energy of the system may be different from various inverter brands

[3] Derating occurs when the operating temperature from -10°C to 10°C & 40°C to 50°C

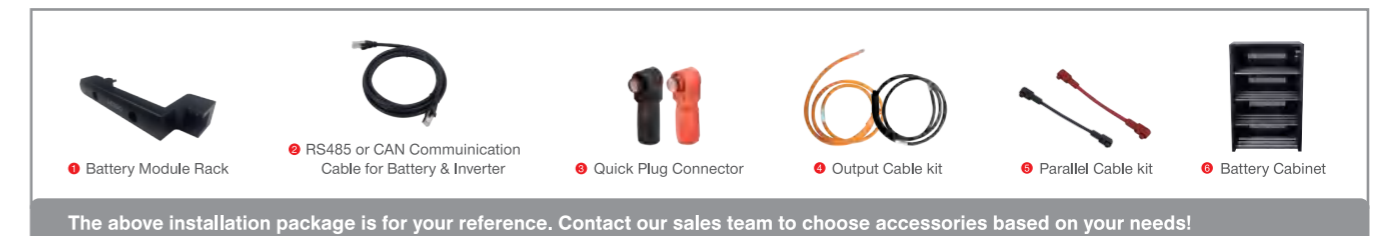

The above installation package is for your reference. Contact our sales team to choose accessories based on your needs!

- 1 Unique rack for stacking installation battery modules.
- 2 The data exchange between the battery and the inverter is necessary, and some models use RS485 mode or CAN mode for communication. Please refer to the user manual for specific model information. The length of this communication cable is 2 meters.
- 3 The terminals of the battery are equipped with specially designed quick plug connector for easy installation and disassembly. Can be used for the battery parallel wires & output wires fabrication.
- 4 Pre fabricated with quick plug connector and pre-insulated terminal, which use for wiring between battery and inverter or combiner box. The length of this cable kit is 2 meters with 25 mm².
- 5 Pre fabricated with quick plug connectors, which use for wiring battery parallel connection. The length of this cable kit is 0.25 meter with 35 mm².
- 6 Battery installation cabinet, there has 6 version for selection. (2/3/6/10/12/16 layers)

Guangdong Lesso Energy Storage Technology Co., Ltd

Daba Industrial Area, Longjiang Town, Foshan City, Guangdong Province, China

LESSO Solar

energy@lessosolar.com www.lessosolar.com







LESSO



Residential Stacked Energy Storage

LSRS series battery packs are stack type residential lithium batteries, designed entirely for residential ESS applications. With our battery technology, you can easily combine it with any mainstream inverter in different scenario to save your electrical bill & back-up your power during grid outage or when power is unavailable.



Features

- 
Safety
 Safer lithium iron phosphate, designed to comply with IEC, UL standards.
- 
Wide compatibility
 Compatible with multiple brands of mainstream inverter use.
- 
Convenient installation
 The installation can be completed by simple stacking.
- 
Long-lasting
 15 years life design. Long cycle life and superior performance.
- 
Scalability
 10.24 KWh ~ 20.48 KWh can be extended.
- 
WiFi optional
 WIFI configuration is optional.



LESSO

Residential Stacked Energy Storage

Items	LSRS205V50AH-LFP	LSRS307V50AH-LFP	LSRS410V50AH-LFP
			
Number of battery modules	2	3	4
Manage battery energy	10.24kWh	15.36kWh	20.48kWh
Nominal voltage	204.8V	307.2V	409.6V
Operation voltage range	185.6V~233.6V	278.4V~350.4V	371.2V~467.2V
Manage battery capacity	50Ah		
Max. charge current	50A		
Max. discharge current	50A		
Communication to inverter	CAN / RS485		
Wifi	Support		
Display	SOC status indicator LED		
IP rating	IP55		
Cycle life	6000 Cycles @25°C @70%EOL @0.2C charge & 0.5C discharge, 90% DOD		
Battery module weight	≈ 60kg		
Module dimension (L*W*H)	630*440*590 mm	630*440*745 mm	630*440*900 mm
Cell type	LFP - Lithium iron phosphate (LiFePO ₄)		
Design life	15 years (25°C/77°F)		
Charge temp. range	0~50°C(32~122°F)		
Discharge temp. range	-10~50°C(14~122°F)		
Operating temperature	Charge:0~50°C(32~122°F) Discharge: -10~55°C (14~131°F)		
Relative humidity	5%~95%		
Install altitude	≤4000m		
Certification	CE / IEC62619 / UL1973 / UL9540A/UN38.3		

1. Test conditions: 90% depth of discharge (DOD), 0.2C rate charge & discharge at 25°C.
2. Charge/discharge derating occurs when the operating temperature from -20°C to 5°C & 45°C to 55°C.
3. The maximum charge and discharge is 1C, the maximum requested charge and discharge current size according to the agreement when connected to the inverter.

Guangdong Lesso Energy Storage Technology Co., Ltd

Daba Industrial Area, Longjiang Town, Foshan City, Guangdong Province, China

 LESSO Solar

 energy@lessosolar.com  www.lessosolar.com

Portable Energy Storage

Let There Be Light, Anywhere, Anytime

- Portable Battery
- Foldable PV Panel





P3 Plus Portable Energy Storage

Features

- Paired with a powerful 300W inverter, be able to power 80% of household device.
- With ultra-safe LiFePO4 batteries and high-quality BMS technology protection, making it a reliable backup power supply.
- Offering 4 charging methods, to ensure that the device maintains the charge reserve anytime and anywhere.
- 4 outputs, AC ports, standard USB-A/Type-C/car port and wireless charging pad, meeting various needs.

Product Model	P3 Plus	
Built-in Battery	Lithium iron phosphate battery (378Wh)	
Input Charging	Power adapter: 120W/20V	
Solar Panel Input	MPPT, 12.5V~25V/8A Max	
Fully Charged Time	FDC solar: 4h; Power adapter: 3.5h	
USB Output	USB1	QC3.0/5V2.4A 9V2A 12V 1.5A /BC1.2 AFC FCP
	USB2	QC3.0/5V2.4A 9V2A 12V 1.5A /BC1.2 AFC FCP
	TYPE-C1	PD65W 5V3.25A 9V3.25A 12V3.25A 15V3.25A 20V3.25A
DC Output	12V/8.3A	
AC Output	Sine Wave Output	CN: 220V+10V, 60Hz/50Hz+3Hz
		US: 110V+10V, 60Hz/50Hz+3Hz
		JP: 100V+10V, 60Hz/50Hz+3Hz
		EU/UK: 230V+10V, 60Hz/50Hz+3Hz
AC Continuous Output	300W	
AC Max Output	600W about 1s	
Solar Input	12.5V-25V 120W (Max)	
Operation Temperature	-10~40°C	
Charging Temperature	0~40°C	
Battery Capacity	378Wh	
Cycle Life	2000 times	
Dimensions(mm)	280 × 210 × 170	
Weight(kg)	5.3	

Remarks: specifications are subject to change without notice

Portable Energy Storage



Features

- UPS uninterruptible charging, emergency support, supports charging while discharging.
- Brand new dual fast charging, fully charged in 2 hours with mains power, fully charged in 4 hours with solar power.
- Compact size, rich interfaces, equipped with outdoor lighting, supports charging with AC and solar panels.

Product Model		P5 Pro
Battery		LiCoO2 22.2V 499.5Wh
Input		Fast charging CN: 200V-240V/50HZ, rated input power: 430W US/JP: 100V-120V/60Hz, rated input power: 430W EU/AU/UK: 220V-240V/50Hz, rated input power: 430W Solar panel: MPPT 100W, 18V~24V, 5.6A
Output	USB-A	MAX 36W 5V3A 9V3A 12V3A support Apple 2.4A, QC2.0/3.0, FCP, AFC, DCP, SCP
	TYPE-C	MAX 60W 5V3A 9V3A 12V3A 15V3A 20V3A support Apple 2.4A, PPS/PD3.0/PD2.0; QC4+/QC4/QC3.0/QC2.0; AFC; FCP; SCP; PE2.0/PE1.1; SFCP fast charging protocol
DC Output	Car Port	12V 10A 120W Max
AC Output	Sine wave	CN: 220V~240VAC single-phase output, 50Hz, rated output power: 600W US/JP: 100V~120VAC single-phase output, 60Hz, rated output power: 600W EU/AU/UK: 220V~240VAC single-phase output, 50Hz, rated output power: 600W
LED Light		Bright - Off - SOS (3 modes cycle)
Cycle Life		>1000 times
Protections		A. over voltage protection B. low voltage protection C. discharge over current protection D. short circuit protection E. charge over current protection F. temperature protection
Accessories		AC charging line / instruction book
Dimensions(mm)		251 * 145 * 152
Weight(kg)		5.1
Charging Temperature		0~45°C
Working Temperature		-20~60°C

Remarks: specifications are subject to change without notice

Product Specification









P6 Plus

Portable Energy Storage

Features

-  Paired with a powerful 600W inverter, be able to power 99% of household device.
-  With ultra-safe LiFePO4 batteries and high-quality BMS technology protection, making it a reliable backup power supply.
-  Offering 4 charging methods, to ensure that the device maintains the charge reserve anytime and anywhere.
-  8 outputs, AC ports, standard USB-A/Type-C/car port and wireless charging pad, meeting various needs.

Product Model		P6 Plus
Builtin Battery		Lithium iron phosphate battery (576Wh)
Input Charging		Power adapter: 120W/20V
Solar Panel Input		MPPT, 12.5V~25V/8A Max
Fully Charged Time		FDC solar: 5.5h Power adapter: 5h
USB Output	USB1	QC3.0/5V2.4A 9V2A 12V 1.5A /BC1.2 AFC FCP
	USB2	QC3.0/5V2.4A 9V2A 12V 1.5A /BC1.2 AFC FCP
	TYPE-C1	PD65W 5V3.25A 9V3.25A 12V3.25A 15V3.25A 20V3.25A
	TYPE-C2	PD30W 5V2.5A 9V2.5A 12V2.5A
DC Output		12V/8.3A
AC Output	Sine Wave Output	CN: 220V+10V, 60Hz/50Hz+3Hz
		US: 110V+10V, 60Hz/50Hz+3Hz
		JP: 100V+10V, 60Hz/50Hz+3Hz
		EU/UK: 230V+10V, 60Hz/50Hz+3Hz
AC Continuous Output		600W
AC Max Output		900W about 1s
Solar Input		12.5V-25V 120W (Max)
Operation Temperature		-10~40°C
Charging Temperature		0~40°C
Battery Capacity		576Wh
Cycle Life		2000 times
Dimensions(mm)		320 × 210 × 226
Weight(kg)		7.1

Remarks: specifications are subject to change without notice





LESSO



CE FC RoHS

Portable Energy Storage

Features

-  Rich output interfaces, suitable for various charging scenarios.
-  High power, large capacity, supporting most electrical appliances.
-  Adapted to 200W solar foldable panel charging, supporting simultaneous charging and discharging.
-  8 output ports, capable of supporting eight devices using electricity simultaneously.

LESSO

Portable Energy Storage

Product model	P10
Built-in Battery	Lithium iron phosphate battery (1008Wh)
Input Charging	Power adapter: 200W/20V
Solar Panel Input	MPPT, 18V~22V/10.0A Max
Fully Charged Time	FDC solar:4h Power adapter:6.5h
USB Output	USB1: QC3.0/5V2.4A 9V2A 12V 1.5A /BC1.2 AFC FCP USB2: 5V2.4A Type-C1: PD65W 5V5A 9V5A 12V5A 15V5A 20V5A Type-C2: 5V2.4A
DC Output	13.5V/9A
AC Output	AC SineWave Output CN: 220V±10V, 60Hz/50Hz±3Hz US/JP: 110V±10V, 60Hz/50Hz±3Hz EU/UK: 230V±10V, 60Hz/50Hz±3Hz
AC Continuous Output	1200W
AC Max Output	2000W about 1s
Solar input	12V-30V 200W (Max)
Operation temperature	-10~40°C
Charging temperature	0~40°C
Battery capacity	1008Wh
Lifecycle	2000 times
Size/weight	290mm * 220mm * 230mm
Weight	10.5kg

Remarks: specifications are subject to change without notice

Product Specification



CN



UK



EU



US/JP

Guangdong Lesso Energy Storage Technology Co., Ltd

Daba Industrial Area, Longjiang Town, Foshan City, Guangdong Province, China





 LESSO Solar

 energy@lessosolar.com  www.lessosolar.com

Portable Energy Storage



Features

-  Wireless charging function, new fast charging, fully charged in 1.5-2 hours with AC power, 5 hours with solar power.
-  AC/USB/car charging and other different interface outputs, convenient for users in various scenarios.
-  4 Type-A ports (36W*4 Max) & 2 Type-C ports (100W*2).
-  Built-in fan for intelligent heat dissipation.

Product model		P20 Pro	
Battery		LiCoO2 43.2V 2203.2Wh	
Input		Fast charging CN: 200V-240V/50HZ, rated input power: 1800W US/JP: 100V-120V/60Hz, rated input power: 1800W EU/AU/UK: 220V-240V/50Hz, rated input power: 1800W Solar panel: MPPT>99% 400W/800W, 18V/36V, 11.2A	
Output	USB Output	USB-A	24W 5V3A 9V2.5A 12V2A support Apple 2.4A; PPS/PD3.0/PD2.0; QC4+/QC4/QC3.0/QC2.0; AFC; FCP; SCP; PE2.0/PE1.1; SFCP fast charging protocol
		TYPE-C	100W 5V3A 9V3A 12V3A 15V3A 20V5A support Apple 2.4A; PPS/PD3.0/PD2.0; QC4+/QC4/QC3.0/QC2.0; AFC; FCP; SCP; PE2.0/PE1.1; SFCP fast charging protocol
	DC Output	Car Port	13.2V 10A 132W Max
		DC5525	13.2V 5A 132W Max
AC Output	Sine Wave	CN: 4 sets 220V~240VAC single-phase output, 50Hz, rated output power: 2200W US/JP: 4 sets 100V~120VAC single-phase output, 60Hz, rated output power: 2200W EU/AU/UK: 4 sets 220V-240VAC single-phase output, 50Hz, rated output power: 2200W	
Wireless Charging		5V/1A; 12V/1.25A support Qi protocol	
LED Light		Medium bright - High bright - SOS - Flash - Off (5 modes cycle)	
Cycle Life		>1000 times	
Protections		A. over voltage protection B. low voltage protection C. discharge over current protection D. short circuit protection E. charge over current protection F. temperature protection	
Accessories		AC charging line / car charging line	
Dimensions(mm)		422*288*306	
Weight(kg)		21	
Charging Temperature		0~45°C	
Working Temperature		-10~45°C	

Remarks: specifications are subject to change without notice

Product Specification



LESSO



Foldable PV Panel



LESSO

19.8V120W

Foldable Solar Panel



PV module dimension Specification

Expanded dimension: 1905*470*25mm

Folded dimension: 470*435*50mm

Product weight: 4.7KG

1.Working mode of solar panel

Working mode of solar panel:

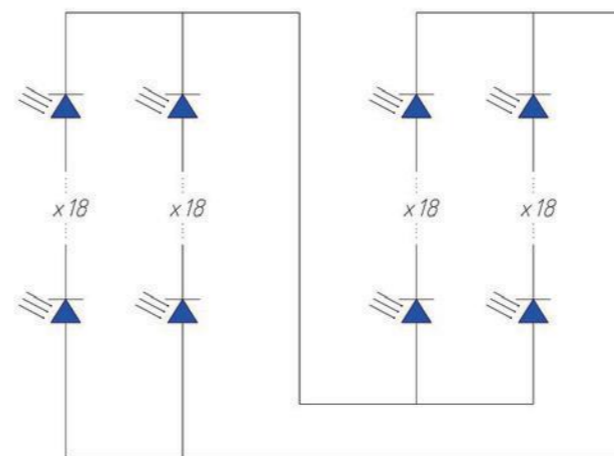

Working principle diagram of solar panel

2.Output Electrical performance parameters of PV module

Output power(@STC) :	120W±5%
Open circuit voltage(@STC) :	24V±5%
Rated operating voltage (@STC):	19.8V±5%
Rated operating current)@STC):	6A±5%
Short circuit current (@STC):	6.3A±5%

Note: STC: Standard Tested Condition (AM=1.5, 25°C, 1000W/m²)

Output port: 1*DC, 1*USB, 1*TYPE-C, 1*XT60, 1*USB fast charging

19.8V200W

Foldable Solar Panel

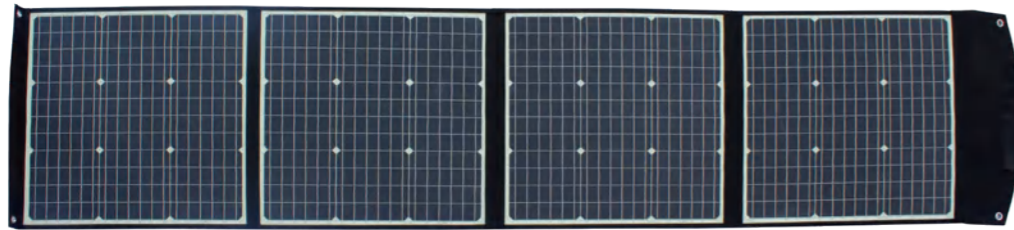

PV module dimension Specification

Expanded dimension: 2460*540*25mm
 Folded dimension: 540*580*60mm
 Product weight: 8KG

1.Working mode of solar panel

Working mode of solar panel:

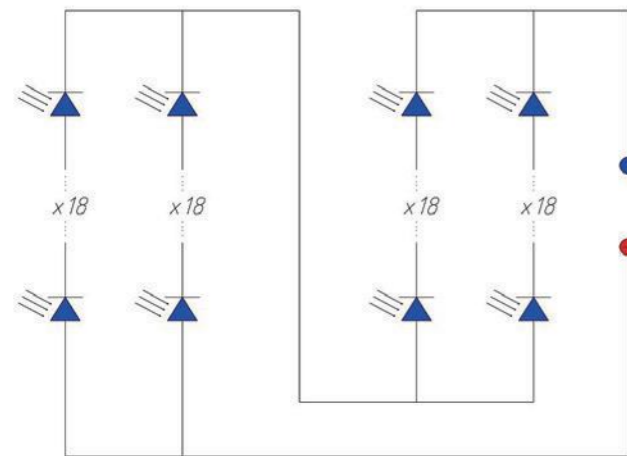

Working principle diagram of solar panel

2.Output Electrical performance parameters of PV module

Output power(@STC) : 200W±5%
 Open circuit voltage(@STC) : 24V±5%
 Rated operating voltage (@STC): 19.8V±5%
 Rated operating current(@STC): 10.1A±5%
 Short circuit current (@STC): 10.6A±5%

Note: STC: Standard Tested Condition
 (AM=1.5, 25°C, 1000W/m²)

Output port: 1*DC, 1*USB, 1*TYPE-C, 1*XT60,
 1*USB fast charging

39V400W

Foldable Solar Panel

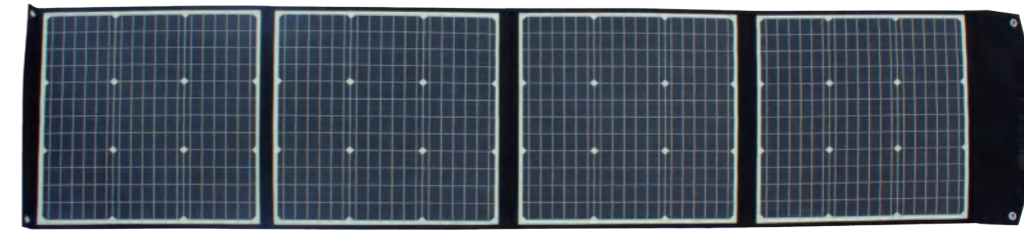

PV module dimension Specification

Expanded dimension: 3160*810*4mm
 Folded dimension: 730*810*25mm
 Product weight: 9.2KG

1.Working mode of solar panel

Working mode of solar panel:

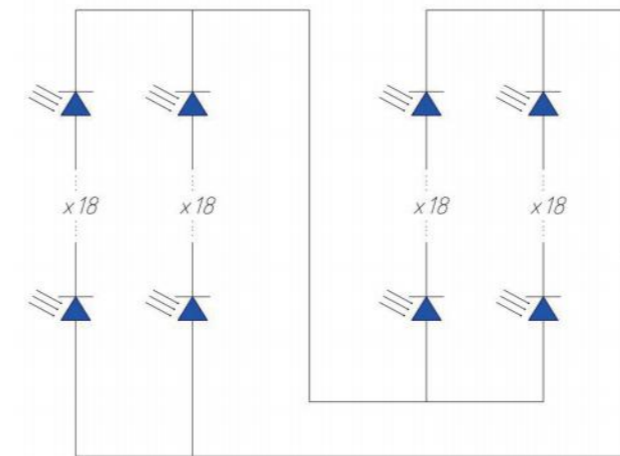

Working principle diagram of solar panel

2.Output Electrical performance parameters of PV module

Output power(@STC) : 400W±5%
 Open circuit voltage(@STC) : 46.8V±5%
 Rated operating voltage (@STC): 39V±5%
 Rated operating current(@STC): 10.3A±5%
 Short circuit current (@STC): 10.8A±5%

Note: STC: Standard Tested Condition
 (AM=1.5, 25°C, 1000W/m²)

Output port: 1*MC4

EV Charger

High Power, Plug and Charge



LESSO



EV Charger

Mobile charge at any time

LESSO

EV Charger



LSACS-E-32/230-B01
LSACS-E-32/230-B03



LSACS-E-32/230-B02
LSACS-E-32/230-B04

Easy switching among multi-gear currents

The default current is 32A, if this current is insufficient for charging at this time, you can adjust the charging current.

Strong compatibility and suitability for various models

Suitable for most new energy vehicle models.

Protection grade: IP66

It has an IP66 waterproof and dust-proof function, and always ensures the charging safety of your car, even in severe outdoor environments.

Technical parameter

Types	LSACS-E-32/230-B01	LSACS-E-32/230-B02	LSACS-E-32/230-B03	LSACS-E-32/230-B04
Output Power	7kW			
Rated Output Voltage	Two-phase 230VAC			
Rated Output Current	32A			
Display Mode	LED light	Display	LED light	Display
Use Method	Swipe card/Bluetooth/Free vend(Optional)		Optional	
Plug Type	Type 2			
Rated Output Frequency	60Hz			
Insulation Resistance	>10MΩ			
Operation Temperature	-20°C~+50°C			
Cable Length	5m (customizable)			
Dimension	Control mainbox: 342 (L) * 214(M) * 116mm (H)			
Flame Retardant Rating	UL94-V0			
Standard	IEC 62196-1:2022, IEC 61851-1-2017			

Reservation charging and avoiding peak hours

To take advantage of the cheap price and save on power, you may schedule a charging session for 1~10 hours

8 Safety features

Protection against overheating, overcurrent, leakage, overvoltage, output exception, CP fault, communication fault, and relay fault.

Compressive, strong and durable

The mainbox is made of high-strength PC material with strong, compressive resistance.

LESSO



EV Charger

Mobile charge at any time

LESSO

EV Charger



LSACS-C-32/240-C01

Easy switching among multi-gear currents

The default current is 32A, if this current is insufficient for charging at this time, you can adjust the charging current.

Strong compatibility and suitability for various models

Suitable for most new energy vehicle models.

Protection grade: IP66

It has an IP66 waterproof and dust-proof function, and always ensures the charging safety of your car, even in severe outdoor environments.

Technical parameter

Types	LSACS-C-32/240-C01	LSACS-C-32/240-C02
Output Power	7kW	
Rated Output Voltage	Two-phase 240VAC	
Rated Output Current	32A	
Display Mode	LED light	Display
Use Method	Swipe card/Bluetooth/Free vend(Optional)	
Plug Type	GBT	
Rated Output Frequency	60Hz	
Insulation Resistance	>10MΩ	
Operation Temperature	-20°C~+50°C	
Cable Length	5m (customizable)	
Dimension	Control mainbox: 342 (L) * 214(M) * 116mm (H)	
Flame Retardant Rating	UL94-V0	
Standard	GB/T18487.1-2023 , GB/T20234.1-2023	



LSACS-C-32/240-C02

Reservation charging and avoiding peak hours

To take advantage of the cheap price and save on power, you may schedule a charging session for 1~10 hours

8 Safety features

Protection against overheating, overcurrent, leakage, overvoltage, output exception, CP fault, communication fault, and relay fault.

Compressive, strong and durable

The mainbox is made of high-strength PC material with strong, compressive resistance.

LESSO

Portable EV Charger



LESSO

Portable EV Charger



LSAC3K5-P-C1



LSAC3K5-P-C2



LSAC7K-P-C1



LSAC7K-P-C2

Easy switching among multi-gear currents

The default current is 10A, if this current is insufficient for charging at this time, you can adjust the charging current.

Strong compatibility and suitability for various models

Suitable for most new energy vehicle models.

Protection grade: IP66

It has an IP66 waterproof and dust-proof function, and always ensures the charging safety of your car, even in severe outdoor environments.

Reservation charging and avoiding peak hours

To take advantage of the cheap price at night and save on power, you may schedule a charging session for 1~10 hours (LSAC3K5-P-C2 / LSAC7K-P-C2 : 1~24hours).

8 Safety features

Protection against overheating, overcurrent, leakage, overvoltage, output exception, CP fault, communication fault, and relay fault.

Compressive, strong and durable

The housing is made of high-strength PC material with strong, compressive resistance.

Technical parameter

Types	LSAC3K5-P-C1	LSAC3K5-P-C2	LSAC7K-P-C1	LSAC7K-P-C2
Output Power	3.5kW		7kW	
Rated Output Voltage	220VAC			
Rated Output Current	13A		32A	
Display Mode	LED light	2.4 "color TFT screen	LED light	2.4 "color TFT screen
Use Method	Plug and charge			
Rated Output Frequency	50Hz			
Insulation Resistance	>10MΩ			
Operation Temperature	-20°C~+50°C			
Cable Length	5m (customizable)			
Dimension	control mainbox: 200 (L) * 90 (M) * 55mm (H)			
Flame Retardant Rating	UL94-V0			
Standard	GB/T20234.2-2015, GB/T18487.1-2015			

Guangdong Lesso Energy Storage Technology Co., Ltd

Daba Industrial Area, Longjiang Town, Foshan City, Guangdong Province, China

LESSO Solar

energy@lessosolar.com www.lessosolar.com

LESSO

EV Charger

High power, plug and charge



LESSO

EV Charger



LSACP-E-16/230-A01



LSACP-E-16/230-A02



LSACP-E-32/230-A01



LSACP-E-32/230-A02

Easy switching among multi-gear currents

The default current is 10A, if this current is insufficient for charging at this time, you can adjust the charging current.

Reservation charging and avoiding peak hours

To take advantage of the cheap price and save on power, you may schedule a charging session for 1~10 hours (LSACP-E-16/230-A02 / LSACP-E-32/230-A02 : 1~24hours).

Strong compatibility and suitability for various models

Suitable for most new energy vehicle models.

8 Safety features

Protection against overheating, overcurrent, leakage, overvoltage, output exception, CP fault, communication fault, and relay fault.

Protection grade: IP66

It has an IP66 waterproof and dust-proof function, and always ensures the charging safety of your car, even in severe outdoor environments.

Compressive, strong and durable

The mainbox is made of high-strength PC material with strong, compressive resistance.

Technical parameter

Types	LSACP-E-16/230-A01	LSACP-E-16/230-A02	LSACP-E-32/230-A01	LSACP-E-32/230-A02
Output Power	3.5kW		7kW	
Rated Output Voltage	230VAC			
Rated Output Current	13A		32A	
Display Mode	LED light	2.4 "color TFT screen	LED light	2.4 "color TFT screen
Use Method	Plug and charge			
Rated Output Frequency	50Hz			
Insulation Resistance	>10MΩ			
Operation Temperature	-20°C~+50°C			
Cable Length	5m (customizable)			
Dimension	Control mainbox: 200 (L) *90 (M) *55mm (H)			
Flame Retardant Rating	UL94-V0			
Optional Plug type	European Standard, US Standard, National Standard three-pronged plug, etc			

Guangdong Lesso Energy Storage Technology Co., Ltd

Daba Industrial Area, Longjiang Town, Foshan City, Guangdong Province, China

LESSO Solar

energy@lessosolar.com www.lessosolar.com

AC&DC integrated charger



Features

1. With 2 DC outputs and 1 AC output, simultaneously charging
2. Flexible power automatic group control function brings efficient charging
3. Hardware level switch monitoring and interlock protection functions
4. Charging module adopts the glue filling process
5. Wide voltage constant power output
6. Smart charging and load balancing
7. Multi-standard plug: CCS2, CHAdeMO, GBT, Type2

Applications

Shopping mall, Public parking, Highway

Model	LSADC-M-202/1000-A	LSADC-M-202/1000-B	LSADC-M-180/1000-C	LSADC-M-180/1000-D	LSADC-M-180/1000-E
Rated power	1xCCS2:Max180kW 1xCHAdeMO:Max60kW 1xType2:Max22kW total:202kW	1xCCS2:Max180kW 1xType2:Max22kW total:202kW	1xCCS2:Max180kW 1xCHAdeMO:Max60kW total:180kW	2xCCS2:Max180kW total:180kW	1xCCS2:Max180kW 1xGBT:Max180kW total:180kW
AC voltage	400VAC±10%				
Power supply	3P+N+PE				
DC Max current	1xCCS2:Max200A 1xCHAdeMO:Max125A 1xType2:Max32A	1xCCS2:Max200A 1xType2:Max32A	1xCCS2:Max200A 1xCHAdeMO:Max125A	2xCCS2:Max200A	2xCCS2:Max200A
AC/DC voltage	1xCCS2:200~1000VDC 1xCHAdeMO:200~500VDC 1xType2:400VAC	1xCCS2:200~1000VDC 1xType2:400VAC	1xCCS2:200~1000VDC 1xCHAdeMO:200~500VDC	2xCCS2:200~1000VDC	2xCCS2:200~1000VDC
Frequency	50/60Hz				
Charge plug	CCS2+CHAdeMO+Type2	CCS2+CCS2+Type2	CCS2+CHAdeMO	CCS2+CCS2	CCS2+GBT
Cable length	5m (Optional)				
Enclosure	Galvanized Steel				
LED indicator	Green/Yellow/Blue/Red				
LCD display	7" color LCD				
RFID	Non-contact (ISO/IEC14443 A)				
Start method	QR code/Card/BLE5.0/PnC				
Interface	BLE5.0/Ethernet/4G/WIFI (Optional)				
Protocol	OCPP1.6J/2.0J (Optional)				
Efficiency	≥95% (Half load and above)				
Power factor	≥0.98 (Rated load)				
Voltage accuracy	≤±0.5%				
Current accuracy	≤±1%				
Energy meter	Accuracy level1.0				
Emergency stop	Yes				
Protection grade	IP55 and IK10				
Certification	CE,CB				
Standard	EN/IEC 61851-1,EN/IEC 61851-23,IEC 61851-24,EN/IEC 61851-21-1				
Installation	Wall mounted/Floor mounted				
Cooling	Forced air cooling				
Temperature	-25°C~+55°C				
Humidity	5%~95%				
Atitude	≤2000m				
Product size	850×850×1800 (W×D×H,mm)				
Net weight	324kg	324kg	318kg	318kg	318kg

Remarks: specifications are subject to change without notice

Industrial and Commercial Energy Storage System



ALL-in-one Outdoor Liquid-cooling Energy Storage System

LSIS 100KW215KWH



Applicable regions and user characteristics

- Large electricity consumers in industrial parks, smart parks, production factories, etc.
- Areas with independent transformers and significant price differences between peak and off-peak electricity rates.
- Regions with large industrial dual-rate electricity consumption and significant fluctuations in load curves during the day.



High Security

- Safe long-life battery cells, fully certified
- IP55, multiple protections
- Battery pack meets North America's UL9540A and NFPA 855 standards
- Thermal runaway of battery cells will not propagate
- No circulating current within a single cluster, no short-circuit between clusters

Easy Configuration

- Easily expandable with parallel machines at any time
- Integrated transportation for easy installation
- Flexible site layout
- Modular design for easy maintenance and upgrades

High Efficiency





- Single discharge capacity exceeds 200kWh, with two charge and two discharge cycles, reaching up to 400kWh
- After 10 years, the energy retention rate is still 70% (with two charge and two discharge cycles)

Longevity

- Battery cycle life can reach up to 6000 times
- Uniformity within <1.6 degrees to increase battery cycle life by 30%
- Liquid cooling mode for longer lifespan
- Designed for a standard operating life of 15 years

On-grid and Off-grid

- Supports both grid-connected and off-grid parallel operation with anti-backflow function
- The number of parallel machines can be expanded at any time

Product Type	LSIS 100KW215KWH
Rated Energy	215kWh@0.5C
Rated Power	105kW
Rated Output Voltage	380/400VAC
Cell Capacity	280Ah
Cell Type	GSP71173204F,3.2V280Ah
Configuration	1P 240S
Maximum Discharge Current	173A
Maximum Charging Current	173A
Frequency	50/60
Operating Temperature Range	-20~+55°C
Communication Port	LAN, RS485
Cooling Method	Liquid Cooling
Protection Level	IP55
Functional Safety	Class B
Product Weight	≈2900kg
Dimensions	W1300*D1300*H2285 mm
Life Cycle	6000 times
Testing&Certification	    

Remarks: Specifications are subject to change without notice; Special voltage and power requirements can be customized designed.

Schematic Diagram

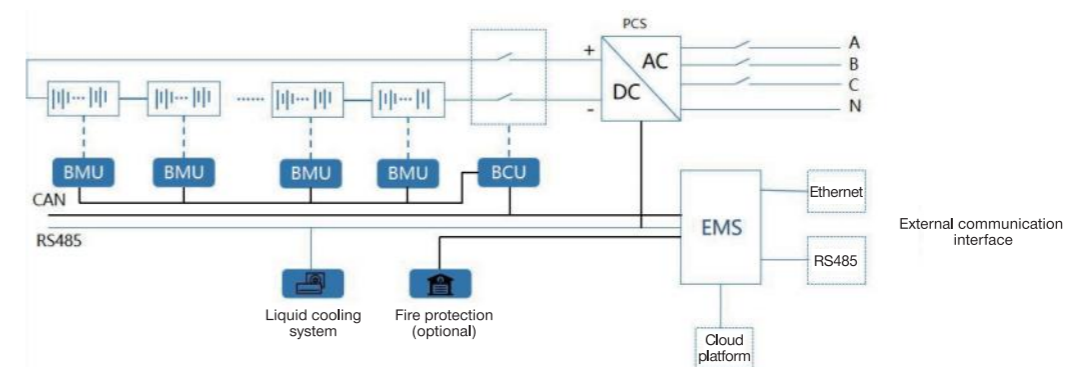



Product characteristics

Reduce costs and increase efficiency

1500V high voltage battery system, reduce line loss
 Intelligent liquid cooling temperature control, auxiliary power consumption reduced by 30%
 Pre-assembly and shipment, shorten the delivery cycle, reduce engineering costs

Efficient and flexible

Modular design, the battery system is easy to replace, easy to add
 Configure cluster-level DC/DC controllers to reduce the barrel effect and increase discharge capacity
 Quickly configure the unified external interface, remote online upgrade, and visual data management

Safe and reliable

The PACK IP67 anti-condensation design completely eliminates the impact of condensation on the battery system
 Intelligent battery system management, battery health prediction, reduce the risk of thermal runaway
 Intelligent leak-proof liquid detection and rehydration system to improve system safety and reliability

Application field

Large-scale industrial and commercial energy storage power station, thermal power combined energy storage power station, wind storage power station, independent energy storage power station, micro-grid and other occasions

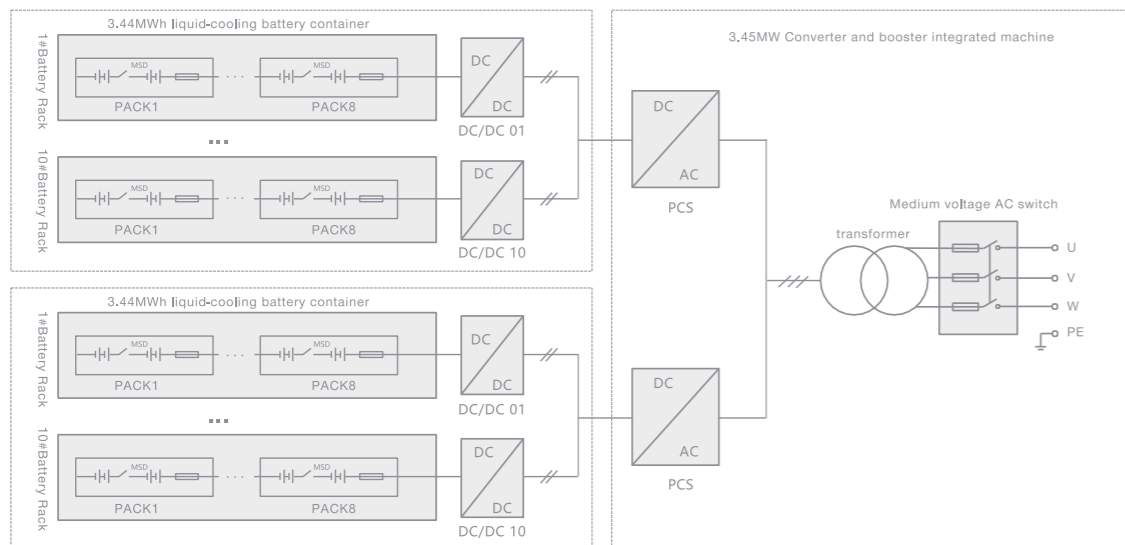

AC Side	Power Rating	3450kVA
	Rated Voltage	35kV/10kV (optional)
	Grid Voltage Range	35kV/10kV $\pm 2.5\%$
	Power Factor	> 0.99 (at rated power)
	Reactive Power Adjustable Range	-105%~105%
	Rated Grid Frequency	50Hz
	Grid Frequency Range	45~55Hz
	AC Current Distortion Rate	< 3% (at rated power)
	DC Component	< 0.5%
	Isolation Mode	Transformer isolation
DC Side	Battery Type	Lithium iron phosphate 3.2V / 280Ah
	System Battery Configuration	2×384S10P
	Battery Rated Capacity	2×3440kWh
	Battery Voltage Range	1075.2~1382.4V
	BMS Communication Interface	485 Communication/CAN/Ethernet
System Parameter	BMS Communication Protocol	Modbus TCP
	Dimensions of Converter and Booster Integrated Machine	6058×2438×3000 (W×D×H, mm)
	Dimensions of Liquid-cooling Battery Container	6058×2438×2896 (W×D×H, mm)
	Weight of Converter and Booster Integrated Machine	< 16 t
	Weight of Liquid-cooling Battery Container	< 35 t
	Degree of Protection	IP54
	Battery Charge/Discharge Operating Temperature	0°C~55°C/-20°C~55°C
	Operating Humidity Range	0~95% (Non-condensing)
	Standard Altitude	< 2000m (> 2000m, derating)
	Battery Temperature Control Mode	liquid-cooling
	Converter Cooling Method	Forced air cooling
	Fire Suppression	NOVEC 1230/FM200
	System Communication Interface	Ethernet / RS485
	External System Communication Protocol	Modbus RTU, Modbus TCP, IEC61850, IEC104
	Compliance	GB/T36276-2018, IEC62619, UL1971, UL9540A

Remarks: Specifications are subject to change without notice; Special voltage and power requirements can be customized designed